

FUJIFILM

BL01549-200 **EN**

DIGITAL CAMERA

FINEPIX Z950EXR

Owner's Manual

Thank you for your purchase of this product. This manual describes how to use your FUJIFILM digital camera and the supplied software. Be sure that you have read and understood its contents and the warnings in "For Your Safety" (📖 ii) before using the camera.

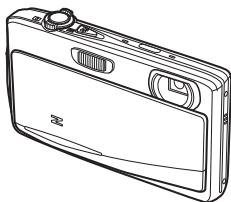

For information on related products, visit our website at http://www.fujifilm.com/products/digital_cameras/index.html

Before You Begin

First Steps

Basic Photography and Playback

More on Photography

More on Playback

Movies

Connections

Menus

Technical Notes

Troubleshooting

Appendix



IMPORTANT SAFETY INSTRUCTIONS

- **Read Instructions:** All the safety and operating instructions should be read before the appliance is operated.
- **Retain Instructions:** The safety and operating instructions should be retained for future reference.
- **Heed Warnings:** All warnings on the appliance and in the operating instructions should be adhered to.
- **Follow Instructions:** All operating and use instructions should be followed.

Installation

Power Sources: This video product should be operated only from the type of power source indicated on the marking label. If you are not sure of the type of power supply to your home, consult your appliance dealer or local power company. For video products intended to operate from battery power, or other sources, refer to the operating instructions.

Grounding or Polarization: This video product is equipped with a polarized alternating-current line plug (a plug having one blade wider than the other). This plug will fit into the power outlet only one way. This is a safety feature. If you are unable to insert the plug fully into the outlet, try reversing the plug. If the plug should still fail to fit, contact your electrician to replace your obsolete outlet. Do not defeat the safety purpose of the polarized plug.

Alternate Warnings: This video product is equipped with a three-wire grounding-type plug, a plug having a third (grounding) pin. This plug will only fit into a grounding-type power outlet. This is a safety feature. If you are unable to insert the plug into the outlet, contact your electrician to replace your obsolete outlet. Do not defeat the safety purpose of the grounding type plug.

Overloading: Do not overload wall outlets and extension cords as this can result in a risk of fire or electric shock.

Ventilation: Slots and openings in the cabinet are provided for ventilation, to ensure reliable operation of the video product and to protect it from overheating, and these openings must not be blocked or covered. The openings should never be blocked by placing the video product on a bed, sofa, rug, or other similar surface.

This video product should not be placed in a built-in installation such as a bookcase or rack unless proper ventilation is provided or the manufacturer's instructions have been adhered to. This video product should never be placed near or over a radiator or heat register.

Attachments: Do not use attachments not recommended by the video product manufacturer as they may cause hazards.

Water and Moisture: Do not use this video product near water—for example, near a bath tub, wash bowl, kitchen sink, or laundry tub, in a wet basement, or near a swimming pool, and the like.

Power-Cord Protection: Power-supply cords should be routed so that they are not likely to be walked on or pinched by items placed upon or against them, paying particular attention to cords at plugs, convenience receptacles, and the point where they exit from the appliance.

Accessories: Do not place this video product on an unstable cart, stand, tripod, bracket, or table. The video product may fall, causing serious injury to a child or adult, and serious damage to the appliance. Use only with a cart, stand, tripod, bracket, or table recommended by the manufacturer, or sold with the video product. Any mounting of the appliance should follow the manufacturer's instructions, and should use a mounting accessory recommended by the manufacturer.

An appliance and cart combination should be moved with care. Quick stops, excessive force, and uneven surfaces may cause the appliance and cart combination to overturn.



Antennas

Outdoor Antenna Grounding: If an outside antenna or cable system is connected to the video product, be sure the antenna or cable system is grounded so as to provide some protection against voltage surges and built-up static charges. Section 810 of the National Electrical Code, ANSI/NFPA No. 70, provides information with respect to proper grounding of the mast and supporting structure, grounding of the lead-in wire to an antenna discharge unit, size of grounding conductors, location of antenna discharge unit, connection to grounding electrodes, and requirements for the grounding electrode.

EXAMPLE OF ANTENNA GROUNDING AS PER NATIONAL ELECTRICAL CODE

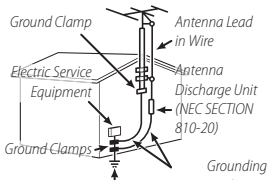

Power Service Grounding Electrode System (NEC ART 250, PART H)

Grounding Conductors (NEC SECTION 810-21)

Power Lines: An outside antenna system should not be located in the vicinity of overhead power lines or other electric light or power circuits, or where it can fall into such power lines or circuits. When installing an outside antenna system, extreme care should be taken to keep from touching such power lines or circuits as contact with them might be fatal.

Use

Cleaning: Unplug this video product from the wall outlet before cleaning. Do not use liquid cleaners or aerosol cleaners. Use a damp cloth for cleaning.

Object and Liquid Entry: Never push objects of any kind into this video product through openings as they may touch dangerous voltage points or short out parts that could result in a fire or electric shock. Never spill liquid of any kind on the video product.

Lightning: For added protection for this video product receiver during a lightning storm, or when it is left unattended and unused for long periods of time, unplug it from the wall outlet and disconnect the antenna or cable system. This will prevent damage to the video product due to lightning and power-line surges.

Service

Servicing: Do not attempt to service this video product yourself as opening or removing covers may expose you to dangerous voltage or other hazards. Refer all servicing to qualified service personnel.

Damage Requiring Service: Unplug this video product from the wall outlet and refer servicing to qualified service personnel under the following conditions:

- When the power-supply cord or plug is damaged.
- If liquid has been spilled, or objects have fallen into the video product.
- If the video product has been exposed to rain or water.
- If the video product has been dropped or the cabinet has been damaged.

If the video product does not operate nor-

mally follow the operating instructions. Ad-just only those controls that are covered by the operating instructions as an improper adjustment of other controls may result in damage and will often require extensive work by a qualified technician to restore the video product to its normal operation.

When the video product exhibits a distinct change in performance—this indicates a need for service.

Replacement Parts: When replacement parts are required, be sure the service technician has used replacement parts specified by the manufacturer or have the same characteristics as the original part. Unauthorized substitutions may result in fire, electric shock or other hazards.

Safety Check: Upon completion of any service or repairs to this video product, ask the service technician to perform safety checks to determine that the video product is in proper operating condition.

Be sure to read these notes before use

Safety Notes

- Make sure that you use your camera correctly. Read these safety notes and your *Owner's Manual* carefully before use.
- After reading these safety notes, store them in a safe place.

About the Icons

The icons shown below are used in this document to indicate the severity of the injury or damage that can result if the information indicated by the icon is ignored and the product is used incorrectly as a result.



This icon indicates that death or serious injury can result if the information is ignored.



This icon indicates that personal injury or material damage can result if the information is ignored.

The icons shown below are used to indicate the nature of the instructions which are to be observed.



Triangular icons tell you that this information requires attention ("Important").



Circular icons with a diagonal bar tell you that the action indicated is prohibited ("Prohibited").



Filled circles with an exclamation mark indicate an action that must be performed ("Required").

! WARNING



If a problem arises, turn the camera off, remove the battery, and disconnect and unplug the AC power adapter. Continued use of the camera when it is emitting smoke, is emitting any unusual odor, or is in any other abnormal state can cause a fire or electric shock. Contact your FUJIFILM dealer.



Do not allow water or foreign objects to enter the camera. If water or foreign objects get inside the camera, turn the camera off, remove the battery, and disconnect and unplug the AC power adapter. Continued use of the camera can cause a fire or electric shock. Contact your FUJIFILM dealer.

! WARNING



Do not use the camera in the bathroom or shower. This can cause a fire or electric shock.



Never attempt to change or take apart the camera (never open the case). Failure to observe this precaution can cause fire or electric shock.



Should the case break open as the result of a fall or other accident, do not touch the exposed parts. Failure to observe this precaution could result in electric shock or in injury from touching the damaged parts. Remove the battery immediately, taking care to avoid injury or electric shock, and take the product to the point of purchase for consultation.



Do not change, heat or unduly twist or pull the connection cord and do not place heavy objects on the connection cord. These actions could damage the cord and cause a fire or electric shock. If the cord is damaged, contact your FUJIFILM dealer.



Do not place the camera on an unstable surface. This can cause the camera to fall or tip over and cause injury.



Never attempt to take pictures while in motion. Do not use the camera while you are walking or driving a vehicle. This can result in you falling down or being involved in a traffic accident.



Do not touch any metal parts of the camera during a thunderstorm. This can cause an electric shock due to induced current from the lightning discharge.



Do not use the battery except as specified. Load the battery as shown by the indicator.







Do not heat, change or take apart the battery. Do not drop or subject the battery to impacts. Do not store the battery with metallic products. Any of these actions can cause the battery to burst or leak and cause fire or injury as a result.



















Use only the battery or AC power adapters specified for use with this camera. Do not use voltages other than the power supply voltage shown. The use of other power sources can cause a fire.



If the battery leaks and fluid gets in contact with your eyes, skin or clothing, flush the affected area with clean water and seek medical attention or call an emergency number right away.

 WARNING	
	Do not use the charger to charge batteries other than those specified here. The supplied battery charger is for use only with the type of battery supplied with the camera. Using the charger to charge conventional batteries or other types of rechargeable batteries can cause the battery to leak fluid, overheat or burst.
	Danger of explosion if battery is incorrectly replaced. Replace only with the same or equivalent type.
	When carrying the battery, install it in a digital camera or keep it in the hard case. When storing the battery, keep it in the hard case. When discarding, cover the battery terminals with insulation tape. Contact with other metallic objects or batteries could cause the battery to ignite or burst.
	Keep memory cards out of the reach of small children. Because memory cards are small, they can be swallowed by children. Be sure to store memory cards out of the reach of small children. If a child swallows a memory card, seek medical attention or call an emergency number.

 CAUTION	
	Do not use this camera in locations affected by oil fumes, steam, humidity or dust. This can cause a fire or electric shock.
	Do not leave this camera in places subject to extremely high temperatures. Do not leave the camera in locations such as a sealed vehicle or in direct sunlight. This can cause a fire.
	Keep out of the reach of small children. This product could cause injury in the hands of a child.
	Do not place heavy objects on the camera. This can cause the heavy object to tip over or fall and cause injury.
	Do not move the camera while the AC power adapter is still connected. Do not pull on the connection cord to disconnect the AC power adapter. This can damage the power cord or cables and cause a fire or electric shock.
	Do not use the AC power adapter when the plug is damaged or the plug socket connection is loose. This could cause a fire or electric shock.
	Do not cover or wrap the camera or the AC power adapter in a cloth or blanket. This can cause heat to build up and distort the casing or cause a fire.

 CAUTION	
	When you are cleaning the camera or you do not plan to use the camera for an extended period, remove the battery and disconnect and unplug the AC power adapter. Failure to do so can cause a fire or electric shock.
 <small>Unplug from power socket</small>	When charging ends, unplug the charger from the power socket. Leaving the charger plugged into the power socket can cause a fire.
	Using a flash too close to a person's eyes may temporarily affect the eyesight. Take particular care when photographing infants and young children.
	When a memory card is removed, the card could come out of the slot too quickly. Use your finger to hold it and gently release the card. Injury could result to those struck by the ejected card.
	Request regular internal testing and cleaning for your camera. Build-up of dust in your camera can cause a fire or electric shock. Contact your FUJIFILM dealer to request internal cleaning every two years. Please note that this service is not free of charge.
	Remove your fingers from the flash window before the flash fires. Failure to observe this precaution could result in burns.
	Keep the flash window clean and do not use the flash if the window is obstructed. Failure to observe these precautions could cause smoke or discoloration.

The Battery and Power Supply

Note: Check the type of battery used in your camera and read the appropriate sections.

The following describes the proper use of batteries and how to prolong their life. Incorrect use can shorten battery life or cause leakage, overheating, fire, or explosion.

Li-ion Batteries

Read this section if your camera uses a rechargeable Li-ion battery.

The battery is not charged at shipment. Charge the battery before use. Keep the battery in its case when not in use.

Notes on the Battery

The battery gradually loses its charge when not in use. Charge the battery one or two days before use.

Battery life can be extended by turning the camera off when not in use.

Battery capacity decreases at low temperatures; a depleted battery may not function at when cold. Keep a fully charged spare battery in a warm place and exchange as necessary, or keep the battery in your pocket or other warm place and insert it in the camera only when shooting. Do not place the battery in direct contact with hand warmers or other heating devices.

Charging the Battery

Charge the battery in the supplied battery charger. Charging times will increase at ambient temperatures below +10°C (+50°F) or above +35°C (+95°F). Do not attempt to charge the battery at temperatures above 40°C (+104°F); at temperatures below 0°C (+32°F), the battery will not charge.

Do not attempt to recharge a fully charged battery. The battery does not however need to be fully discharged before charging.

The battery may be warm to the touch immediately after charging or use. This is normal.

Battery Life

At normal temperatures, the battery can be recharged about 300 times. A noticeable decrease in the length of time the battery will hold a charge indicates that it has reached the end of its service life and should be replaced.

Storage

Performance may be impaired if the battery is left unused for extended periods when fully charged. Run the battery flat before storing it.

If the camera will not be used for an extended period, remove the battery and store it in a dry place with an ambient temperature of from +15°C to +25°C (+59°F to +77°F). Do not store in locations exposed to extremes of temperature.

Cautions: Handling the Battery

- Do not transport or store with metal objects such as necklaces or hairpins.
- Do not expose to flame or heat.
- Do not disassemble or modify.
- Use with designated chargers only.
- Do not drop or subject to strong physical shocks.
- Do not expose to water.
- Keep the terminals clean.
- The battery and camera body may become warm to the touch after extended use. This is normal.

AA Alkaline/Rechargeable Ni-MH Batteries

Read this section if your camera uses AA alkaline or rechargeable AA Ni-MH batteries. Information on compatible battery types may be found elsewhere in the camera manual.

Cautions: Handling the Batteries

- Do not expose to water, flame, or heat, or store in warm or humid conditions.
- Do not transport or store with metal objects such as necklaces or hairpins.
- Do not disassemble or modify the batteries or battery casing.
- Do not subject to strong physical shocks.
- Do not use batteries that are leaking, deformed, or discolored.
- Keep out of reach of infants and small children.
- Insert in the correct orientation.

- Do not mix old and new batteries, batteries with different charge levels, or batteries of different types.
- If the camera will not be used for an extended period, remove the batteries. Note that the camera clock will be reset.
- The batteries may be warm to the touch immediately after use. Turn the camera off and allow the batteries to cool before handling.
- Battery capacity tends to decrease at low temperatures. Keep spare batteries in a pocket or other warm place and exchange as necessary. Cold batteries may recover some of their charge when warmed.
- Fingerprints and other stains on the battery terminals can impair battery performance. Thoroughly clean the terminals with a soft, dry cloth before inserting them in the camera.



If the batteries leak, clean the battery compartment thoroughly before inserting new batteries.



If fluid from the battery comes into contact with skin or clothing, flush the affected area with water. **If fluid enters your eyes, immediately flush the affected area with water and seek medical attention. Do not rub your eyes. Failure to observe this precaution could result in permanent visual impairment.**

■ Ni-MH Batteries

The capacity of Ni-MH batteries may be temporarily reduced when new, after long periods of disuse, or if they are repeatedly recharged before being fully discharged. This is normal and does not indicate a malfunction. Capacity can be increased by repeatedly discharging the batteries using the discharge option in the camera setup menu and recharging them using a battery charger.

ⓘ **CAUTION:** Do not use the discharge option with alkaline batteries.

The camera draws a small amount of current even when off. Ni-MH batteries that have been left in the camera for an extended period may be drawn down to the point that they no longer hold a charge. Battery performance may also drop if the batteries are run down in a device such as a flashlight. Use the discharge option in the camera setup menu to discharge Ni-MH batteries. Batteries that no longer hold a charge even after repeatedly being discharged and recharged have reached the end of their service life and must be replaced.

Ni-MH batteries can be recharged in a battery charger (sold separately). Batteries may become warm to the touch after charging. Refer to the instructions provided with the charger for more information. Use the charger with compatible batteries only.

Ni-MH batteries gradually lose their charge when not in use.

■ Disposal

Dispose of used batteries in accord with local regulations.

AC Power Adapters (Available Separately)

This section applies to all camera models.

Use only FUJIFILM AC power adapters designated for use with this camera. Other adapters could damage the camera.

- The AC power adapter is for indoor use only.
- Be sure the DC plug is securely connected to the camera.
- Turn the camera off before disconnecting the adapter. Disconnect the adapter by the plug, not the cable.
- Do not use with other devices.
- Do not disassemble.
- Do not expose to high heat and humidity.
- Do not subject to strong physical shocks.
- The adapter may hum or become hot to the touch during use. This is normal.
- If the adapter causes radio interference, reorient or relocate the receiving antenna.

Using the Camera

Do not aim the camera at extremely bright light sources, such as the sun in a cloudless sky. Failure to observe this precaution could damage the camera image sensor.

Take Test Shots

Before taking photographs on important occasions (such as at weddings or before taking the camera on a trip), take a test shot and view the result in the LCD monitor to ensure that the camera is functioning normally. FUJIFILM Corporation can not accept liability for damages or lost profits incurred as a result of product malfunction.

Notes on Copyright

Unless intended solely for personal use, images recorded using your digital camera system cannot be used in ways that infringe copyright laws without the consent of the owner. Note that some restrictions apply to the photographing of stage performances, entertainments, and exhibits, even when intended purely for personal use. Users are also asked to note that the transfer of memory cards containing images or data protected under copyright laws is only permissible within the restrictions imposed by those copyright laws.

Handling

To ensure that images are recorded correctly, do not subject the camera to impact or physical shocks while images are being recorded.

Liquid Crystal

In the event that the LCD monitor is damaged, care should be taken to avoid contact with liquid crystal. Take the urgent action indicated should any of the following situations arise:

- **If liquid crystal comes in contact with your skin**, clean the area with a cloth and then wash thoroughly with soap and running water.
- **If liquid crystal enters your eyes**, flush the affected eye with clean water for at least 15 minutes and then seek medical assistance.
- **If liquid crystal is swallowed**, rinse your mouth thoroughly with water. Drink large quantities of water and induce vomiting, then seek medical assistance.

Although the display is manufactured using extremely high-precision technology, it may contain pixels that are always lit or that do not light. This is not a malfunction, and images recorded with the product are unaffected.

Trademark Information

xD-Picture Card and **SD** are trademarks of FUJIFILM Corporation. The typefaces included herein are solely developed by Dyna-Comware Taiwan Inc. Macintosh, QuickTime, and Mac OS are trademarks of Apple Inc. in the U.S.A. and other countries. Windows 7, Windows Vista, and the Windows logo are trademarks of the Microsoft group of companies. Adobe and Adobe Reader are either trademarks or registered trademarks of Adobe Systems Incorporated in the U.S.A. and/or other countries. The SDHC and SDXC logos are trademarks of SD-3C, LLC. The HDMI logo is a trademark. YouTube is a trademark of Google Inc. All other trade names mentioned in this manual are the trademarks or registered trademarks of their respective owners.

Electrical Interference

This camera may interfere with hospital or aviation equipment. Consult with hospital or airline staff before using the camera in a hospital or on an aircraft.

Color Television Systems

NTSC (National Television System Committee) is a color television telecasting specification adopted mainly in the U.S.A., Canada, and Japan. PAL (Phases Alternation by Line) is a color television system adopted mainly in European countries and China.

Exif Print (Exif Version 2.3)

Exif Print is a newly revised digital camera file format in which information stored with photographs is used for optimal color reproduction during printing.

IMPORTANT NOTICE: Read Before Using the Software

Direct or indirect export, in whole or in part, of licensed software without the permission of the applicable governing bodies is prohibited.

About This Manual

Before using the camera, read this manual and the warnings in “For Your Safety” (📖 ii). For information on specific topics, consult the sources below.

Table of Contents 📖 xi

The “Table of Contents” gives an overview of the entire manual. The principal camera operations are listed here.

Troubleshooting 📖 105

Having a specific problem with the camera? Find the answer here.

Warning Messages and Displays ... 📖 111

Find out what’s behind that flashing icon or error message in the display.

Memory Cards

Pictures can be stored in the camera’s internal memory or on optional SD, SDHC, and SDXC memory cards (📖 17), referred to in this manual as “memory cards.”

The HOME Button

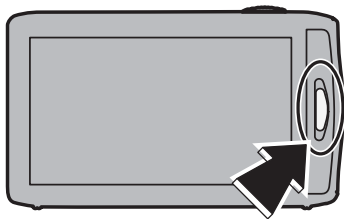

■ Taking Pictures During Playback

- ➔ To return instantly to shooting mode, press the **HOME** button.

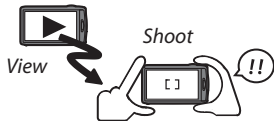

■ Turning the Camera on in Playback Mode

- ➔ When the camera is off, playback can be started by pressing the **HOME** button for about a second. Press the **HOME** button again to turn the camera off.



■ Viewing Pictures from the Playback Menu

- ➔ When playback menu is displayed, exit to viewing pictures by pressing the **HOME** button.



Table of Contents

For Your Safety	ii
IMPORTANT SAFETY INSTRUCTIONS	ii
Safety Notes	iv
About This Manual	ix
The HOME Button	x
Before You Begin	
Symbols and Conventions	1
Supplied Accessories	1
Parts of the Camera	2
Camera Displays (Touch Panel)	4
Shooting	4
Playback	5
The Touch Panel Display	6
Tap	6
Scroll	6
Playback Zoom	6
Rotating the Camera	8
Shooting	8
Playback	9
Touch Panel Icons	10
Shooting	10
Playback	11









First Steps

















Charging the Battery	12
Inserting the Battery and a Memory Card	14
Compatible Memory Cards	17
Turning the Camera on and Off	19
Shooting Mode	19
Playback Mode	19
Basic Setup	21

Basic Photography and Playback















Taking Pictures in  (EXR AUTO) Mode	23
Viewing Pictures	28













More on Photography























Shooting Mode	29
 (EXR AUTO/EXR Priority)	30
 (EXR AUTO)	30
 Priority	31
 AUTO	32
 TOUCH EXR AUTO/  TOUCH & SHOOT	32
 SCENE POSITION	33
 MOTION PANORAMA 360	35
 NATURAL LIGHT	37
 NATURAL & 	37
 PROGRAM AE	37

Focus Lock	38
 Exposure Compensation	40
 Using the Flash (Super-Intelligent Flash)	41
 Using the Self-Timer	43
 Macro Mode (Close-ups)	44
 Intelligent Face Detection	45
 Continuous Shooting	46
 Face Recognition	47
Adding New Faces	47
Editing Existing Data	49
Adding Faces Automatically	50
More on Playback	
Playback Options	52
★ Favorites: Rating Pictures	52
Playback Zoom	53
 Multi-Frame Playback	55
 Deleting Pictures	57
 Image Search	58
 PhotoBook Assist	60
Creating a PhotoBook	60
Viewing Photobooks	61
Editing and Deleting Photobooks	61
Edit	
 COLLAGE	63
 IMAGE ROTATE	64
 CROP	64
 RESIZE	65
 RED EYE REMOVAL	65
Viewing Panoramas	66
Movies	
Recording Movies	67
Movie Frame Size	68
Viewing Movies	69
Connections	
Connecting the Camera to High Definition (HD) TVs	70
Printing Pictures via USB	72
Viewing Pictures on a Computer	74
Windows: Installing MyFinePix Studio	74
Macintosh: Installing FinePixViewer	76
Connecting the Camera	78

Menus

Using the Menus: Shooting Mode	81
Using the Shooting Menu.....	81
Shooting Menu Options	82
 EXP. COMPENSATION.....	82
 ISO.....	82
 IMAGE SIZE.....	83
 IMAGE QUALITY	83
 MOVIE MODE.....	84
 D-RANGE DYNAMIC RANGE	84
 FILM SIMULATION	84
 WHITE BALANCE	85
 CONTINUOUS SHOOTING SETUP	85
 FACE DETECTION	85
 AF MODE.....	86
 MOVIE AF MODE	86
 ADVANCED ANTI BLUR	87
 INTELLIGENT SHARPNESS.....	87
 SET-UP	87

Using the Menus: Playback Mode	88
Using the Playback Menu.....	88
Playback Menu Options.....	88
 PHOTOBOK ASSIST.....	88
 FAVORITES	88
 PICTURE COMPARE	88
 IMAGE SEARCH	89
 EDIT	89
 SLIDE SHOW	89
 PROTECT.....	90
 COPY.....	90
 ERASE FACE RECOG.	91
 ERASE	91
 MARK FOR UPLOAD TO	92
 SET-UP	93

The Setup Menu	94
Using the Setup Menu	94
Setup Menu Options	94
 DUAL IS MODE	94
 SILENT MODE	94
 INTELLIGENT DIGITAL ZOOM	95
 BEST FRAMING	95
 SAVE ORG IMAGE	95
 IMAGE DISP.	96
 FRAME NO.	96
 ILLUMINATION	97
 DATE/TIME	97
 VOLUME	97
 SOUND	97
 LCD BRIGHTNESS	97
 FORMAT	97
 言語/LANG.	98
 AUTO POWER OFF	98
 TIME DIFFERENCE	98
 RED EYE REMOVAL	99
 AUTOROTATE PB	99
 BACKGROUND COLOR.....	99
 POWER MANAGEMENT	99
 RESET	100
 CALIBRATION	100
 VERSION INFO	100

Technical Notes

Optional Accessories	101
Accessories from FUJIFILM	102
Caring for the Camera	103
Storage and Use	103
Cleaning	104
Traveling	104

Troubleshooting

Problems and Solutions	105
Warning Messages and Displays	111

Appendix

Tips and Tricks	116
Internal Memory/Memory Card Capacity	119
Specifications	120

Before You Begin

Symbols and Conventions

The following symbols are used in this manual:

- ⓘ : This information should be read before use to ensure correct operation.
- 📌 : Additional information that may be helpful when using the camera.
- 📖 : Other pages in this manual on which related information may be found.

Menus and other text in the LCD monitor are shown in **bold**. In the illustrations in this manual, displays may be simplified for explanatory purposes.

Supplied Accessories

The following items are included with the camera:

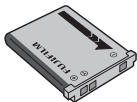

NP-45A rechargeable battery

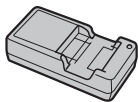

BC-45C battery charger



Plug adapter*

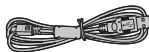

USB cable



CD-ROM
(contains this manual)

- Strap
- *Basic Manual*

Attaching the Strap

Attach the strap as shown.

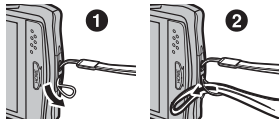

* Shape of adapter varies with region of sale.

Parts of the Camera

For more information, refer to the page listed to the right of each item.

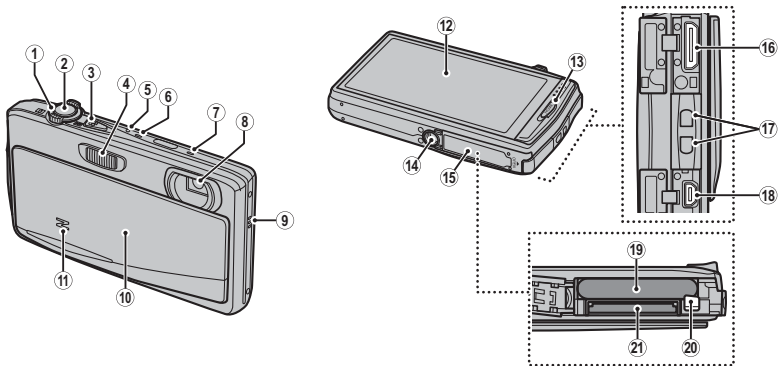

1 Zoom control	25, 53	12 LCD monitor	122
2 Shutter button	26	Touch panel display	4, 6, 8
3 (movie recording) button	67	13 HOME button	19
4 Flash	41	14 Tripod mount	
5 Indicator lamp	3	15 Battery-chamber cover	14
6 Microphone (R)	67	16 HDMI mini connector	70
7 Microphone (L)	67	17 Strap eyelet	1
8 Lens	120	18 Connector for USB cable	72, 78
9 Speaker	69	19 Battery chamber	14
10 On/off switch and lens cover	19	20 Battery latch	14, 16
11 Illuminator	97	21 Memory card slot	15
Self-timer lamp	43		

 **The Indicator Lamp**

The indicator lamp shows camera status as follows:

Indicator lamp	Camera status
Glows green	Focus locked.
Blinks green	Blur, focus, or exposure warning. Picture can be taken.
Blinks green and orange	Recording pictures. Additional pictures can be taken.
Glows orange	Recording pictures. No additional pictures can be taken at this time.
Blinks orange	Flash charging; flash will not fire when picture is taken.
Blinks red	Lens or memory error.

Camera Displays (Touch Panel)

The following types of indicator may be displayed during shooting and playback. Indicators vary with camera settings.

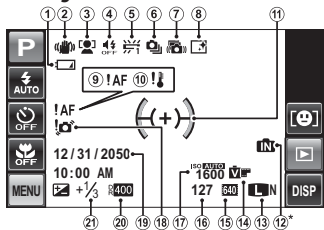
Shooting

1	Battery level	5
2	Dual IS mode	94
3	Intelligent Face Detection indicator	45
4	Silent mode indicator	94
5	White balance.....	85
6	Continuous shooting mode.....	46
7	Advanced anti blur.....	31
8	Intelligent sharpness	87
9	Focus warning	111
10	Temperature warning	108
11	Focus frame	38
12	Internal memory indicator*	
13	Image size/quality.....	83
14	Film simulation	84
15	Movie mode.....	68
16	Number of available frames.....	119
17	Sensitivity.....	82
18	Blur warning.....	42, 111
19	Date and time	21
20	Dynamic range	84
21	Exposure compensation.....	40

* **IN**: indicates that no memory card is inserted and that pictures will be stored in the camera's internal memory (15).



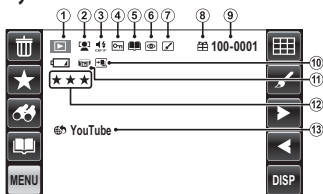

■ Playback



1	Playback mode indicator.....	28, 52
2	Intelligent Face Detection indicator	45, 91
3	Silent mode indicator	94
4	Protected image	90
5	Photobook assist.....	60
6	Red-eye removal indicator.....	65, 99
7	Edit	62
8	Gift image.....	52
9	Frame number.....	96
10	Advanced anti blur.....	31
11	Motion panorama 	92
12	Favorites	52
13	Mark for upload to.....	92

Battery Level

Battery level is shown as follows:

Indicator	Description
 (white)	Battery partially discharged.
 (white)	Battery more than half discharged.
 (red)	Low battery. Charge as soon as possible.
 (blinks red)	Battery exhausted. Turn camera off and charge battery.

Hiding and Viewing Indicators

Tap **DISP** to cycle through shooting and playback indicators as follows: all icons and indicators displayed/all icons and indicators hidden/only button icons displayed.

The Touch Panel Display

The touch panel display can be operated by tapping the display or gliding a finger over the panel. The panel responds to pressure; use a firm touch, but do NOT use excessive force.

■ Tap

Lightly tap the display to adjust settings or select pictures or menu options.

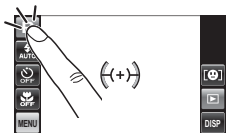

■ Scroll

Slide lightly over the display to scroll through pictures during playback.



■ Playback Zoom

Place two fingers on the display and slide them apart to zoom in.

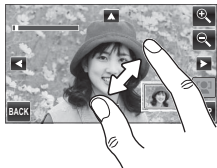

Slide them together to zoom out.

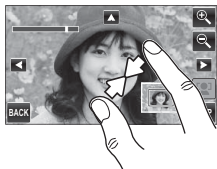

- ⓘ Note that some LCD monitor covers may affect the visibility of the image in the monitor or make the monitor less responsive. To avoid damaging the monitor and touch panel display, observe the following precautions:
- Use only your fingers to operate the panel. Do not use excessive force.
 - Do not sit on the camera (by, for example, leaving it in a back pocket when sitting down), place it under heavy objects, or attempt to force it into a small space (such as a suitcase that is already full).
 - Do not attach objects to the camera strap that might place pressure on the monitor.

Rotating the Camera

With some exceptions, the display in the LCD monitor rotates 90° when the camera is in “tall” orientation.

■ Shooting

Camera held in “wide”
(landscape) orientation

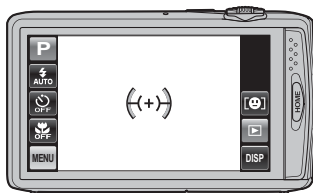

Camera held in “wide”
(landscape) orientation



Camera held in “tall”
(portrait) orientation

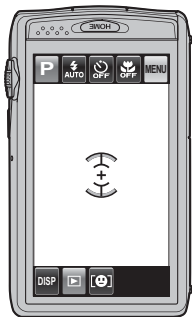

Camera held in “tall”
(portrait) orientation

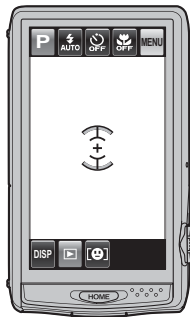

■ Playback

Camera held in "wide"
(landscape) orientation



Camera held in "wide"
(landscape) orientation



Camera held in "tall"
(portrait) orientation

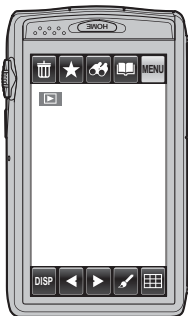

Camera held in "tall"
(portrait) orientation

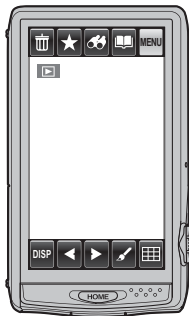

Touch Panel Icons

■ Shooting

Tap the icons in the shooting display to perform the operations listed below. The icons displayed vary with the options currently selected.

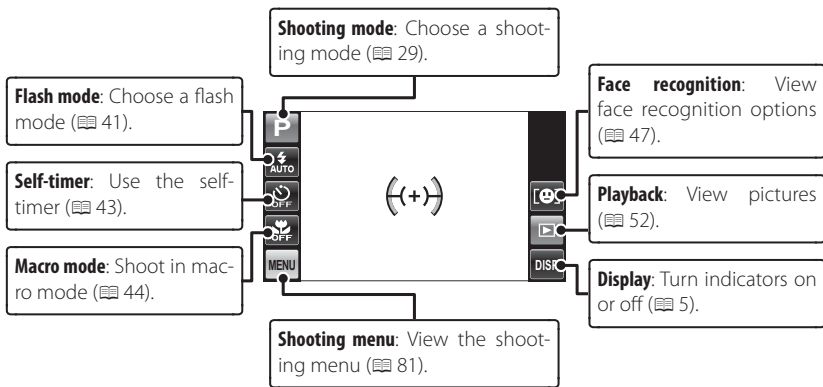

■ Playback

Tap the icons in the playback display to perform the operations listed below. The icons displayed vary with the type of picture and the current playback mode.

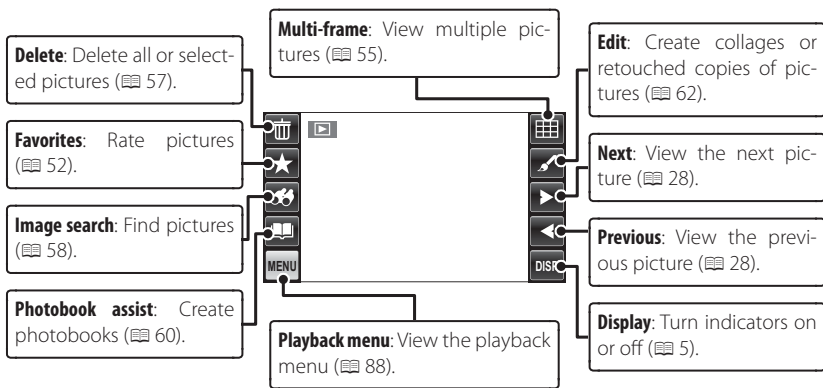

First Steps

Charging the Battery

The battery is not charged at shipment. Charge the battery before use.

1 Attach the plug adapter.

Attach the plug adapter as shown at right, making sure that it is fully inserted and clicks into place on the charger terminals.

- ⓘ The plug adapter is exclusively for use with the supplied battery charger. Do not use it with other devices.

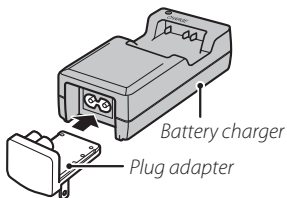

2 Place the battery in the supplied battery charger.

Insert the battery in the orientation indicated by the ⊕ ⊗ ⊖ labels.

The camera uses an NP-45A rechargeable battery.

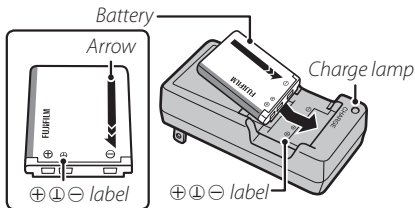

3 Plug the charger in.

Plug the charger into an indoor power outlet. The charging indicator will light.



The Charging Indicator

The charging indicator shows battery charge status as follows:

Charging indicator	Battery status	Action
Off	Battery not inserted.	Insert the battery.
On (green)	Battery fully charged.	Remove the battery.
On (orange)	Battery charging.	—
Blinks (orange)	Battery fault.	Unplug the charger and remove the battery.

4 Charge the battery.

Remove the battery when charging is complete. See the specifications (📖 124) for charging times (note that charging times increase at low temperatures).

ⓘ Unplug the charger when it is not in use.

Inserting the Battery and a Memory Card

Although the camera can store pictures in internal memory, optional SD, SDHC, and SDXC *memory cards* (sold separately) can be used to store additional pictures. After charging the battery, insert the battery and memory card as described below.

1 Open the battery-chamber cover.

❖ Be sure the camera is off before opening the battery-chamber cover.

Ⓢ Do not open the battery-chamber cover when the camera is on. Failure to observe this precaution could result in damage to image files or memory cards.

Ⓢ Do not use excessive force when handling the battery-chamber cover.

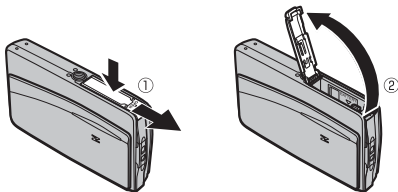

2 Insert the battery.

Insert the battery with the terminal first and in the orientation shown by the label inside the battery chamber, keeping the battery latch pressed to one side. Confirm that the battery is securely latched.

Ⓢ Insert the battery in the correct orientation. **Do not use force or attempt to insert the battery upside down or backwards.** The battery will slide in easily in the correct orientation.

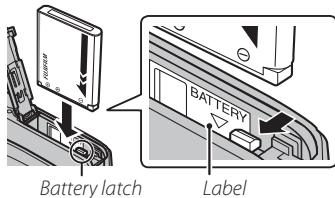

3 Insert the memory card.

Holding the memory card in the orientation shown at right, slide it in until it clicks into place at the back of the slot.

- ① Be sure card is in the correct orientation; do not insert at an angle or use force. If the memory card is not correctly inserted or no memory card is inserted, **IN** will appear in the LCD monitor and internal memory will be used for recording and playback.
- ① SD/SDHC/SDXC memory cards can be locked, making it impossible to format the card or to record or delete images. Before inserting an SD/SDHC/SDXC memory card, slide the write-protect switch to the unlocked position.

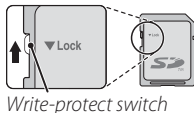
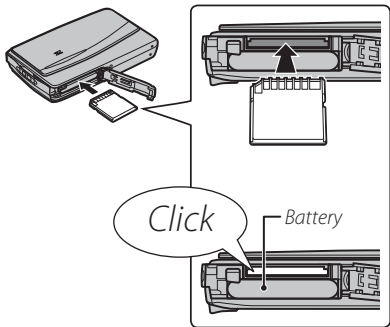

4 Close the battery-chamber cover.

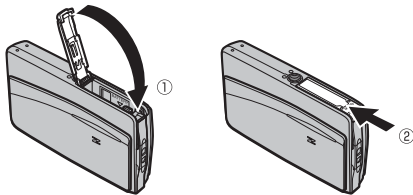

◆ Using an AC Power Adapter

- The camera can be powered by an optional AC power adapter and DC coupler (sold separately). See the manuals provided with the AC power adapter and DC coupler for details.
- Depending on the country or region of sale, a demo mode slide show may start if the camera is turned on while powered by an AC power adapter. Press the shutter button to end the show.

●● Removing the Battery and Memory Card

Before removing the battery or memory card, **turn the camera off** and open the battery-chamber cover.

To remove the battery, press the battery latch to the side, and slide the battery out of the camera as shown.

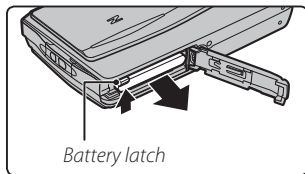

To remove the memory card, press it in and release it slowly. The card can then be removed by hand. When a memory card is removed, the card could come out of the slot too quickly. Use your finger to hold it and gently release the card.

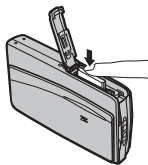

■ Compatible Memory Cards

FUJIFILM and SanDisk SD, SDHC, and SDXC memory cards have been approved for use in the camera. A complete list of approved memory cards is available at http://www.fujifilm.com/support/digital_cameras/compatibility/. Operation is not guaranteed with other cards. The camera can not be used with *xD-Picture Cards* or MultiMediaCard (MMC) devices.

ⓘ Memory Cards

- *Do not turn the camera off or remove the memory card while the memory card is being formatted or data are being recorded to or deleted from the card.* Failure to observe this precaution could damage the card.
- Format SD/SDHC/SDXC memory cards before first use, and be sure to reformat all memory cards after using them in a computer or other device. For more information on formatting memory cards, see “ **FORMAT**” (📖 97).
- Memory cards are small and can be swallowed; keep out of reach of children. If a child swallows a memory card, seek medical assistance immediately.
- miniSD or microSD adapters that are larger or smaller than the standard dimensions of an SD/SDHC/SDXC card may not eject normally; if the card does not eject, take the camera to an authorized service representative. Do not forcibly remove the card.
- Do not affix labels to memory cards. Peeling labels can cause camera malfunction.
- Movie recording may be interrupted with some types of SD/SDHC/SDXC memory card. Use a **CLASS 4** card or better when shooting HD or high-speed movies.

- The data in internal memory may be erased or corrupted when the camera is repaired. Please note that the repairer will be able to view pictures in internal memory.
- Formatting a memory card or internal memory in the camera creates a folder in which pictures are stored. Do not rename or delete this folder or use a computer or other device to edit, delete, or rename image files. Always use the camera to delete pictures from memory cards and internal memory; before editing or renaming files, copy them to a computer and edit or rename the copies, not the originals.

① Batteries

- Remove dirt from the battery terminals with a clean, dry cloth. Failure to observe this precaution could prevent the battery from charging.
- Do not affix stickers or other objects to the battery. Failure to observe this precaution could make it impossible to remove the battery from the camera.
- Do not short the battery terminals. The battery could overheat.
- Read the cautions in “The Battery and Power Supply” (📖 vi).
- Use only battery chargers designated for use with the battery. Failure to observe this precaution could result in product malfunction.
- Do not remove the labels from the battery or attempt to split or peel the outer casing.
- The battery gradually loses its charge when not in use. Charge the battery one or two days before use.

Turning the Camera on and Off

Shooting Mode

To turn the camera on, open the lens cover fully. The camera turns off when the lens cover is closed.

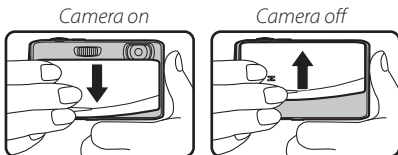

Playback Mode

If the lens cover is closed, the camera can be turned on in playback mode by pressing the **HOME** button for about a second.

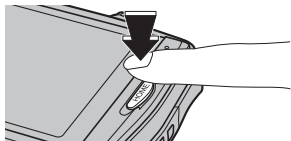

To turn the camera off, press and hold the **HOME** button.

◆ **Switching to Shooting Mode**

To exit to shooting mode, press the shutter button halfway.

- ❗ Fingerprints and other marks on the lens can affect pictures. Keep the lens clean.
- ❗ Turning the camera off does not completely end the supply of power to the camera.
- ❗ The indicator lamp lights when the camera is turned off. Do not remove the battery while the lamp is lit. The camera can not be turned on again until the lamp turns off.

🔒 **Auto Power Off**

The camera will turn off automatically if no operations are performed for the length of time selected for  **AUTO POWER OFF** (📖 98).

Basic Setup

A language-selection dialog is displayed the first time the camera is turned on. Set up the camera as described below (you can reset the clock or change languages at any time using the 🕒 **DATE/TIME** or 🗣️ **言語/LANG.** options in the setup menu; for information on displaying the setup menu, see page 94).

- 1 Tap to select a language. Tap ▲ or ▼ to view additional languages.

👉 “NO” and “BACK”

Tap **BACK** to return to the previous step, **NO** to skip the current step. Any steps you skip will be displayed the next time the camera is turned on.



- 2 The date will be displayed. Tap the ▲ or ▼ arrows to set the date and then tap **OK**. To change the order in which the year, month, and day are displayed, tap **YY.MM.DD**.

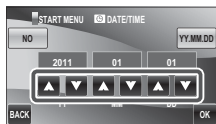

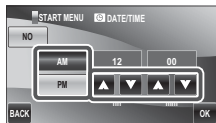

- 3 The time will be displayed. Select **AM** or **PM**, tap the ▲ or ▼ arrows to set the time, and tap **OK**.



- 4 Tap a shooting mode.

5 Power management options will be displayed. Tap one of the following options:

-  **POWER SAVE:** Save battery power.
-  **CLEAR DISPLAY:** Choose for a brighter, higher quality display.

Tap **OK** to enter shooting mode when setup is complete.



The Camera Clock

If the battery is removed for an extended period, the camera clock will be reset and the language-selection dialog will be displayed when the camera is turned on.

Basic Photography and Playback

Taking Pictures in **EXR AUTO** (**EXR AUTO**) Mode

This section describes how to take pictures in **EXR AUTO** (**EXR AUTO**) mode.

1 Turn the camera on.

Fully open the lens cover.

2 Select **EXR AUTO** mode.

Tap the shooting mode icon to view shooting modes and tap **EXR AUTO**.

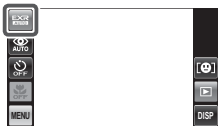

3 Display EXR options.

A description will be displayed. Tap the description to continue, or wait for it to clear from the display automatically.



4 Select **EXR**.

Tap **EXR AUTO** to select **EXR AUTO** mode and then tap **OK** to exit to shooting mode.



The Icon

In **EXR AUTO** mode, the camera continuously adjusts focus and searches for faces, increasing the drain on the battery.  is displayed in the LCD monitor.



Scene Icons (30)

The camera automatically selects the appropriate scene.

-  The camera analyses the scene and selects the preferred **EXR** mode when the shutter button is pressed halfway ( 31).

5 Frame the picture.

Use the zoom control to frame the picture in the display.

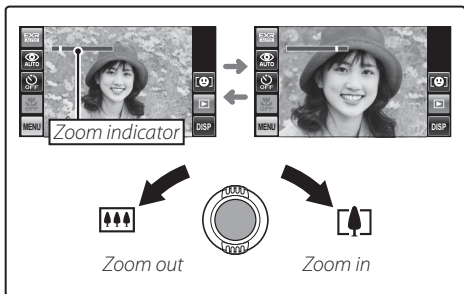

Holding the Camera

Hold the camera steady with both hands and brace your elbows against your sides. Shaking or unsteady hands can blur your shots.



To prevent pictures that are out of focus or too dark (underexposed), keep your fingers and other objects away from the lens and flash.

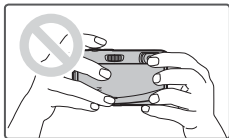

6 Focus.

Press the shutter button halfway to focus.

- ◆ The lens may make a noise when the camera focuses; this is normal.

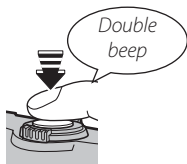

If the camera is able to focus, it will beep twice and the indicator lamp will glow green.

If the camera is unable to focus, the focus frame will turn red, **!AF** will be displayed, and the indicator lamp will blink green. Change the composition or use focus lock (📖 38).

7 Shoot.

Smoothly press the shutter button the rest of the way down to take the picture.

- ◆ If the subject is poorly lit, the flash may fire when the picture is taken. For information on using the flash when lighting is poor, see “[Using the Flash \(Super-Intelligent Flash\)](#)” (41).



The Shutter Button

The shutter button has two positions. Pressing the shutter button halfway sets focus and exposure; to shoot, press the shutter button the rest of the way down.

Viewing Pictures

Pictures can be viewed in the LCD monitor. When taking important photographs, take a test shot and check the results.

1 Tap the icon.

The most recent picture will be displayed.



2 View additional pictures.

Scroll left or right or tap  or .











Press the shutter button to exit to shooting mode.

More on Photography

Shooting Mode

Choose a shooting mode according to the scene or type of subject. Tap the shooting mode icon in the LCD monitor and tap the icon for the desired mode.



Mode	See	Mode	See
 EXR	30	 MOTION PANORAMA 360	35
 AUTO	32	 NATURAL LIGHT	37
 TOUCH EXR AUTO/	32	 NATURAL & ↓	37
 TOUCH & SHOOT		 PROGRAM AE	37
 SCENE POSITION	33		

A description of the selected mode will be displayed; tap the description to continue, or wait for it to clear from the display automatically.

EXR (EXR AUTO/EXR Priority)

Optimize settings for your current subject or improve clarity, reduce noise, or enhance dynamic range. Choose one of the following **EXR** modes in the shooting menu.

**EXR AUTO (EXR AUTO)**

The camera automatically selects the scene and **EXR** mode according to shooting conditions (📖 23).

- ❖ If **AUTO** is selected for **IMAGE SIZE** in **EXR AUTO** mode, the camera will automatically select the optimal image size.
- ❖ **INTELLIGENT DIGITAL ZOOM** is restricted to 2x (📖 95).

*Scene icon***The Scene Icon**



The camera selects from the following scenes:



Scene		AUTO	LAND-SCAPE	NIGHT	MACRO	BEACH	SUNSET	SNOW	SKY	GREENERY	SKY & GREENERY
Main subject		📷	🌄	🌃*	📷	🏖️	🌅	❄️	☁️	🌿	🌳
Non-portrait		📷	🌄	🌃*	📷	🏖️	🌅	❄️	☁️	🌿	🌳
Portrait	Normal	👤	👤🌄	👤🌃*	—	👤🏖️	👤🌅	👤❄️	👤☁️	👤🌿	👤🌳
	Backlit	👤	👤🌄	—	—	👤🏖️	👤🌅	👤❄️	👤☁️	👤🌿	👤🌳
Moving object		📷	🌄	🌃	📷	🏖️	🌅	❄️	☁️	🌿	🌳
Portrait and motion	Normal	👤	👤🌄	👤🌃	—	👤🏖️	👤🌅	👤❄️	👤☁️	👤🌿	👤🌳
	Backlit	👤	👤🌄	—	—	👤🏖️	👤🌅	👤❄️	👤☁️	👤🌿	👤🌳

* If 📷 is displayed, the camera will take a series of shots (advanced anti-blur; 📖 31).

- ① The mode selected may vary with shooting conditions. If the mode and subject do not match, select **📷** mode (📖 32) or choose **SP** (📖 33) and select a scene manually.



Advanced Anti Blur

When  is displayed, the camera will take a series of exposures and combine them to form a single image, reducing “noise” (mottling) and blur. Pictures taken using this process are indicated by a  icon during playback.

- ◆  is available when **ON** is selected in the shooting menu ( 87) and the flash ( 41) is off or set to auto.
- ① Some time may be required to combine the exposures into a single image. A single combined image may not be created if the subject or camera moves during shooting. Keep the camera steady during shooting and do not move the camera until shooting is complete.
- ① Frame coverage is reduced.



The EXR Icon

When the shutter button is pressed halfway, the camera chooses the preferred **EXR** mode:

-  (**RESOLUTION PRIORITY**): Produces crisp, clear shots.
-  (**HIGH ISO & LOW NOISE**): Reduces noise in pictures taken at high sensitivities.
-  (**D-RANGE PRIORITY**): Increases the amount of detail visible in highlights.

■ **EXR** Priority

Select this mode to manually choose from the following **EXR** modes:

-  (**RESOLUTION PRIORITY**): Choose for crisp, clear shots.
-  (**HIGH ISO & LOW NOISE**): Reduce noise in pictures taken at high sensitivities.
-  (**D-RANGE PRIORITY**): Increase the amount of detail visible in highlights.

 **DYNAMIC RANGE** ( 84) can be set to  (1600%) and  (800%).

AUTO

Choose for crisp, clear snapshots. This mode is recommended in most situations.



TOUCH EXR AUTO / **TOUCH & SHOOT**

Choose this mode to take pictures by touching the display instead of pressing the shutter button. Choose

TOUCH EXR AUTO

(the camera automatically selects the appropriate scene and **EXR** modes when a picture is taken) or



TOUCH & SHOOT

, then touch anywhere inside the “touch and shoot” area to focus on the selected subject and take a picture.

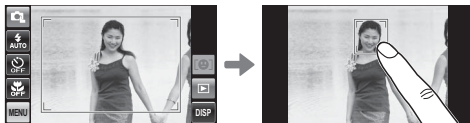















- ❖ If a face is detected in  mode, the camera will focus on the face rather than on the selected subject.

SP SCENE POSITION

The camera offers a choice of “scenes,” each adapted to particular shooting conditions or a specific type of subject. Choose from the following options:



Scene	Description
 PORTRAIT	Choose for portraits.
 PORTRAIT ENHANCER	Choose for a smooth skin effect when shooting portraits.
 LANDSCAPE	Choose for daylight shots of buildings and landscapes.
 SPORT	Choose when photographing moving subjects.
 NIGHT	Choose this mode for poorly lit twilight or night scenes.
 NIGHT (TRIPOD)	Choose this mode for slow shutter speeds when shooting at night.
 FIREWORKS	Slow shutter speeds are used to capture the expanding burst of light from a firework.
 SUNSET	Choose this mode to record the vivid colors in sunrises and sunsets.
 SNOW	Choose for crisp, clear shots that capture the brightness of scenes dominated by shining white snow.
 BEACH	Choose for crisp, clear shots that capture the brightness of sunlit beaches.
 PARTY	Capture indoor background lighting under low-light conditions.
 FLOWER	Choose for vivid close-ups of flowers.
 TEXT	Take clear pictures of text or drawings in print.
 DOG	Choose when photographing dogs.
 CAT	Choose when photographing cats.

DOG/CAT

The camera focuses on the faces of dogs or cats that are facing the camera, and the self-timer menu offers a  **AUTO RELEASE** option that releases the shutter automatically when a pet is detected (📖 43). During playback, image search (📖 58) can be used to search for pictures taken in either mode.

◆ Although camera can detect many different breeds of dogs and cats, results may vary with the breed and shooting conditions. The camera may fail to detect pets with dark-colored faces or long hair covering their entire face. If a dog or cat is not detected, the camera focuses on the subject at the center of the frame.

MOTION PANORAMA 360

Follow an on-screen guide to take photos that will automatically be joined to form a panorama. The camera zooms all the way out and zoom remains fixed at the widest angle until shooting is complete.

1 Tap  and select the pan direction.



2 Tap  and select the angle through which you will pan the camera while shooting.

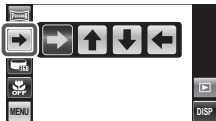

3 Press the shutter button all the way down to start recording. There is no need to keep the shutter button pressed during recording.

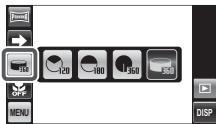

4 Pan the camera in the direction shown by the arrow. Shooting ends automatically when the progress bar is full and the panorama is complete.

- Shooting ends if the shutter button is pressed all the way down during shooting. No panorama will be recorded if the shutter button is pressed before the camera has been panned through 120°.

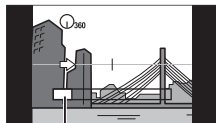





Progress bar

- ① Panoramas are created from multiple frames. The camera may in some cases record an greater or lesser angle than selected or be unable to stitch the frames together perfectly. The last part of the panorama may not be recorded if shooting ends before the panorama is complete.
- ① Shooting may be interrupted if the camera is panned too quickly or too slowly. Panning the camera in a direction other than that shown cancels shooting.
- ① The desired results may not be achieved with moving subjects, subjects close to the camera, unvarying subjects such as the sky or a field of grass, subjects that are in constant motion, such as waves and waterfalls, or subjects that undergo marked changes in brightness. Panoramas may be blurred if the subject is poorly lit.



Choose  for seamless 360° panoramas that can be played back in a loop (📖 66).

◆ The  **SAVE ORG IMAGE** option in the setup menu can be used to record a  panorama in addition to a seamless  panorama (📖 95).

- ① Depending on the subject and shooting conditions, the camera may produce distorted results or a  panorama. The top and bottom of the area visible in the shooting display are cropped out and white strips may appear at the top and bottom of the display.

For Best Results

For best results, move the camera in a small circle at a steady speed, keeping the camera horizontal and being careful only to pan in the direction shown by the guides. If the desired results are not achieved, try panning at a different speed.

N NATURAL LIGHT

Capture natural light indoors, under low light, or where the flash can not be used. The flash turns off and sensitivity is raised to reduce blur.

**N⁺ NATURAL & Flash**

This mode helps ensure good results with backlit subjects and in other situations with difficult lighting. Each time the shutter button is pressed, the camera takes two shots: one shot without the flash to preserve natural lighting, followed immediately by a second shot with the flash. Do not move the camera until shooting is complete.

**P PROGRAM AE**

The camera sets exposure automatically.



Focus Lock

To compose photographs with off-center subjects:

1 Focus: Position the subject in the focus frame (⬅️(+)) and press the shutter button halfway to lock focus and exposure. Focus and exposure will remain locked while the shutter button is pressed halfway (AF/AE lock).



2 Recompose: Keep the button pressed halfway.



3 Shoot: Press the button all the way down.



 **Autofocus**

Although the camera boasts a high-precision autofocus system, it may be unable to focus on the subjects listed below. If the camera is unable to focus, focus on another subject at the same distance and use focus lock to recompose the photograph.

- Very shiny subjects such as mirrors or car bodies.
- Fast-moving subjects.
- Subjects photographed through a window or other reflective object.
- Dark subjects and subjects that absorb rather than reflect light, such as hair or fur.
- Insubstantial subjects, such as smoke or flame.
- Subjects that show little contrast with the background (for example, subjects in clothing that is the same color as the background).
- Subjects positioned in front of or behind a high-contrast object that is also in the focus frame (for example, a subject photographed against a backdrop of highly contrasting elements).

Exposure Compensation

To adjust exposure compensation when photographing very bright, very dark, or high-contrast subjects, tap **MENU** to display the shooting menu and select  **EXP. COMPENSATION** (📖 82). Tap ▲ or ▼ to choose an exposure compensation value and then tap **OK**.

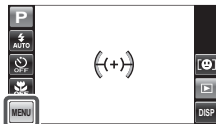

Choose positive values (▲)
to increase exposure



Choose negative values (▼)
to reduce exposure







- ❖ A  icon and exposure indicator are displayed at settings other than ± 0 . Exposure compensation is not reset when the camera is turned off; to restore normal exposure control, choose a value of ± 0 .
- ❖ Turn the flash off when using exposure compensation.

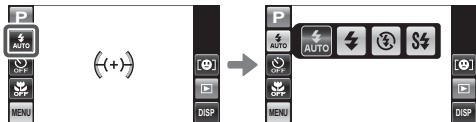

⚡ Using the Flash (Super-Intelligent Flash)

When the flash is used, the camera's *Super-Intelligent Flash* system instantly analyzes the scene based on such factors as the brightness of the subject, its position in the frame, and its distance from the camera. Flash output and sensitivity are adjusted to ensure that the main subject is correctly exposed while preserving the effects of ambient background lighting, even in dimly-lit indoor scenes. Use the flash when lighting is poor, for example when shooting at night or indoors under low light.





Tap the flash icon and choose from the following flash modes:



Option	Description
 (AUTO FLASH)	The flash fires when required. Recommended in most situations.
 (FORCED FLASH)	The flash fires whenever a picture is taken. Use for backlit subjects or for natural coloration when shooting in bright light.
 (SUPPRESSED FLASH)	The flash does not fire even when the subject is poorly lit. Use of a tripod is recommended.
 (SLOW SYNCHRO)	Capture both the main subject and the background under low light (note that brightly lit scenes may be overexposed).

- ❖ If the flash will fire,  will be displayed when the shutter button is pressed halfway. At slow shutter speeds,  will appear in the display to warn that pictures may be blurred; use of a tripod is recommended.
- ❖ The flash may fire several times with each shot. Do not move the camera until shooting is complete.
- ❖ The flash may cause vignetting.





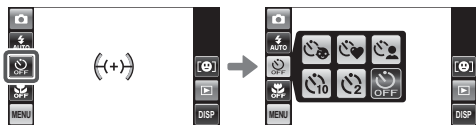

Red-Eye Removal

When Intelligent Face Detection ( 45) and red-eye removal ( 99) are on, red-eye removal is available in auto (; RED EYE REDUCTION), flash on (; FORCED FLASH), and slow sync (; RED EYE & SLOW) modes. Red-eye removal minimizes “red-eye” caused when light from the flash is reflected from the subject’s retinas.



⌚ Using the Self-Timer

To use the self-timer, tap the self-timer icon and choose from the following options:



Option	Description
 (AUTO RELEASE)	The shutter is released automatically when the camera detects a human portrait subject facing the camera. Use for portraits of babies. ◆ Tap STOP to end the auto-release timer.
 (COUPLE TIMER)	The camera starts the timer when it detects two portrait subjects close together. Tap ◀ or ▶ to choose how close the subjects must be together before the timer starts (the more hearts, the closer the subjects must be together). ◆ To stop the timer before the picture is taken, press the shutter button halfway.
 (GROUP TIMER)	The camera will start the timer when it detects the selected number of portrait subjects. Tap ◀ or ▶ to choose the number of subjects. ◆ To stop the timer before the picture is taken, press the shutter button halfway.
 (10 SEC)	The shutter is released ten seconds after the shutter button is pressed. Use for self-portraits. The self-timer lamp on the front of the camera lights when the timer starts and begins to blink shortly before the photo is taken.
 (2 SEC)	The shutter is released two seconds after the shutter button is pressed. Use to reduce blur caused by the camera moving when the shutter button is pressed. The self-timer lamp will blink as the timer counts down.
 (OFF)	Self-timer off.

Macro Mode (Close-ups)

For close-ups, tap the macro mode icon and select . When macro mode is in effect, the camera focuses on subjects near the center of the frame. Use the zoom control to compose pictures ( 25).

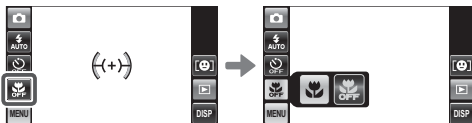

To exit macro mode, tap the macro mode icon and select .

- ◆ Use of a tripod is recommended to prevent blur caused by camera shake.

Intelligent Face Detection

Intelligent Face Detection sets focus and exposure for human faces anywhere in the frame, preventing the camera from focusing on the background in group portraits. Choose for shots that emphasize portrait subjects.

To use Intelligent Face Detection, tap **MENU** to display the shooting menu and select **ON** for  **FACE DETECTION** (📖 85). Faces can be detected with the camera in vertical or horizontal orientation; if a face is detected, it will be indicated by a green border. If there is more than one face in the frame, the camera will select the face closest to the center; other faces are indicated by white borders.

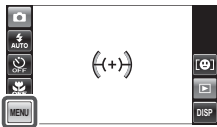

Green border

- ❗ In some modes, the camera may set exposure for the frame as a whole rather than the portrait subject.
- ❗ If the subject moves as the shutter button is pressed, their face may not be in the area indicated by the green border when the picture is taken.





Continuous Shooting

Capture motion in a series of pictures.

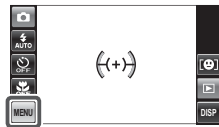
- 1 Tap **MENU** to display the shooting menu and select  **CONTINUOUS SHOOTING SETUP** (📖 85).

- 2 Choose a frame rate and number of frames.



- ◆ The flash turns off automatically. The previously selected flash mode is restored when **OFF** is selected for  **CONTINUOUS SHOOTING SETUP**.
- ◆ Frame rate varies with shutter speed.
- ◆ Focus and exposure are determined by the first frame in each series.
- ◆ The number of pictures that can be recorded depends on the memory available.
- ◆ Options for  **CONTINUOUS SHOOTING SETUP** are restricted to **3frames/s (3frames)** and **OFF** when  or  is selected for **SP**, or in **EXR**, **N**, or **EXR** mode.

[👤] Face Recognition

The camera can store information on the face and personal details (name, relationship, and birth date) of portrait subjects and assign these subjects priority for Intelligent Face Detection or display their names and other information during playback.



Adding New Faces

Follow the steps below to add faces to the face recognition database.

1 Select REGISTER.

Tap [👤] to display face recognition options and tap **REGISTER**.

🔍 To disable face recognition, select **OFF**.

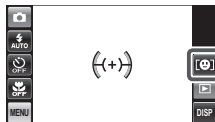

2 Take a photograph.

After checking that the subject is facing the camera, frame the subject using the guides and take the photograph. A confirmation dialog will be displayed; tap **REGISTER** to add the face to the database, **RETRY** to try again (if an error is displayed, tap **BACK** and try again).



3 Enter a name, relationship, and birth date.

The following options will be displayed:

- **NAME:** Enter a name as described in “Text Entry”, below.
- **CATEGORY:** Tap the option that describes your relationship to the subject.
- **BIRTHDAY:** Tap the ▲ and ▼ arrows to enter the subject’s date of birth, then tap **OK**.

◆ If you zoom in on the face of a person in the face recognition database on their birthday, the camera will display their name and the message “Happy Birthday!”

4 Tap **OK**.

After confirming that the information you have entered is correct, tap **OK** to return to the face recognition menu.

Text Entry

1 Tap the text entry mode button until the desired text entry mode (uppercase letters, symbols, or numbers) is displayed.



Mode button

- 2 To enter a character, tap the desired button one or more times (for example, tap the **PQRS** button once to enter “P”, three times to enter “R”).
- 3 To proceed to the next character, tap ►. To delete an existing character, tap ◀ or ► to highlight the character and tap **DEL**. Names may be up to 14 characters long.
- 4 Tap **OK** when text entry is complete.

Editing Existing Data

Follow the steps below to view, edit, or delete face recognition data.

1 Select VIEW & EDIT.

Tap [👤] to display face recognition options and tap **VIEW & EDIT**.

2 Select a face.

The faces in the database will be displayed. Tap a face to display face recognition data for the selected subject.

3 View or edit face recognition data.

The name, category, or birth date can be edited as described in Step 3 of “Adding New Faces” (📖 47). To retake the photo, tap **REPLACING IMAGE** and shoot a new portrait as described above.

Tap **BACK** to exit when you have finished viewing or editing the face recognition data. To delete face recognition data for the selected subject, tap 🗑️.

Adding Faces Automatically

To automatically add frequently-photographed subjects to the face recognition database, select **ON** for **AUTO REGISTRATION** in the face recognition menu. If the camera detects a face that has been photographed many times without being added to the database, it will display a message prompting you to create a new face recognition entry. Tap **OK** and enter face recognition data.

- ❖ The camera may sometimes fail to recognize new faces automatically. If necessary, faces can be added manually using the **REGISTER** option.

Face Recognition

The camera can store up to eight faces. If you attempt to add a ninth face, a confirmation dialog will be displayed; use **VIEW & EDIT** to make room for new faces by deleting existing data. **AUTO REGISTRATION** is disabled if there are already data for eight faces.

When Intelligent Face Detection (🗨️ 45) is on and the frame contains multiple subjects from the face recognition database, the camera displays the name of the subject that will be used to set focus and exposure (the subject shown by the green frame). If no name is entered, the camera will show “---”. Subjects identified using face recognition but not used to set focus and exposure are shown by orange frames, other subjects by white frames.



🔍 The camera may fail to identify subjects in the face recognition database if they are not facing the camera or are only partly in the frame, or if details of the subjects' faces or expressions differ markedly from those in the database.

More on Playback

Playback Options

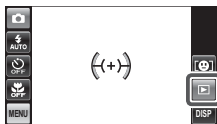
To view the most recent picture, tap .



Scroll left or right or tap  or  to view additional pictures.

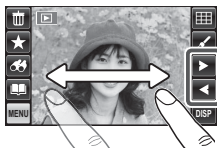

❖ Pictures taken using other cameras are indicated by a  ("gift image") icon during playback.

★ ***Favorites: Rating Pictures***

To rate the picture currently displayed in full-frame playback, tap . A ratings dialog will be displayed; tap to select a rating of from zero to five stars.

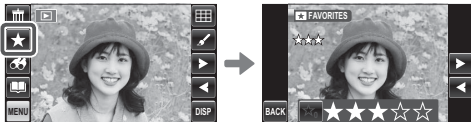

❖ Pictures can also be rated in the playback menu ( 88).

Playback Zoom

To zoom a picture in or out:

- 1 Display the picture full screen and touch the picture with two or more fingers to activate zoom.

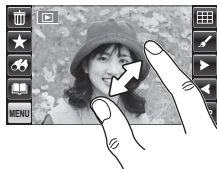

- 2 Tap the display to zoom in on the selected area, or place two fingers on the screen and spread them apart to zoom in or pinch them together to zoom out. When the picture is zoomed in, you can scroll the display by gliding a finger over the image.

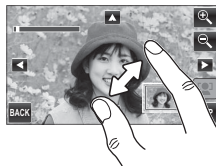

Zoom in



Zoom out

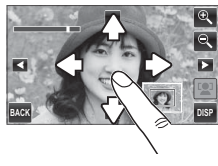









Scroll

Tap **BACK** to exit zoom.

- ◆ The maximum zoom ratio varies with image size. Playback zoom is not available with cropped or resized copies saved at a size of **640** or smaller.



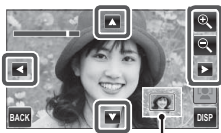

Zoom Controls

During playback zoom ( 53), you can also zoom in or out by tapping  or  and scroll the display by tapping , , , or  (you can also select  with the camera zoom control to display the zoom slider and use the zoom control to zoom in and out;  25).





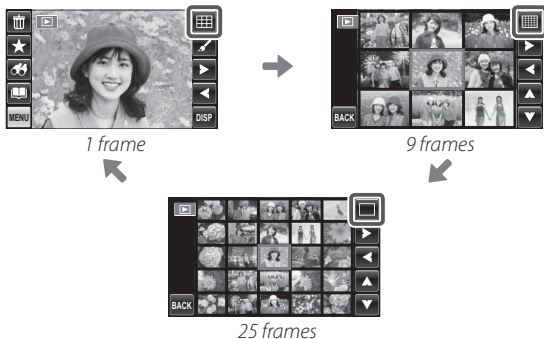

Navigation window shows portion of image currently visible in the display

Multi-Frame Playback

To view pictures nine at a time, tap  in single-frame view. The number of pictures displayed changes each time you tap  (you can also select  with the camera zoom control to increase the number of pictures displayed or  to decrease the number of pictures).



In 9- and 25-frame views, scroll left or right or tap , , , or  to view more pictures.

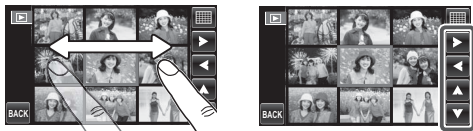



Tap a picture to view it full screen.

Rotating the Camera





When the camera is held in “tall” (portrait) orientation, the highlighted picture appears at the top of the display. Tap ▲, ▼, ◀, or ▶ to highlight pictures and tap the picture at the top of the display to view it full screen.



Deleting Pictures

To delete individual pictures, multiple selected pictures, or all pictures, tap **MENU** during playback to display the playback menu, select  **ERASE** ( 91), and choose from the options below. *Note that deleted pictures can not be recovered. Copy important pictures to a computer or other storage device before proceeding.*



Option	Description
FRAME	Tap  or  to scroll through pictures and tap  . A confirmation dialog will be displayed; tap OK to delete the current picture. Tap BACK to return to playback when all the desired pictures have been deleted.
SELECTED FRAMES	Tap pictures to select or deselect (pictures that are currently selected for photobooks and other playback menu operations may be shown by ). When the operation is complete, tap OK to display a confirmation dialog and tap OK to delete the selected pictures.
ALL FRAMES	A confirmation dialog will be displayed; tap OK to delete all unprotected pictures (if a memory card is inserted, the pictures will be deleted from the memory card; the pictures in internal memory are only deleted if no memory card is inserted). Tapping BACK cancels deletion; note that any pictures deleted before you tapped BACK can not be recovered.



-  Protected pictures can not be deleted. Remove protection from any pictures you wish to delete ( 90).

Image Search

Search for pictures.



- 1 Tap the  icon in single-frame view.



- 2 Choose from the following options:

Option	Description
BY DATE	Search by date.
BY FACE	Search for faces from the face recognition database.
BY ★ FAVORITES	Search by rating (🗨 52).
BY SCENE	Search by scene.
BY TYPE OF DATA	Find all still pictures, all movies, or edited pictures.
BY UPLOAD MARK	Find all pictures selected for upload to a specified destination (🗨 92).

- ◆ Searches can also be performed from the playback menu (🗨 89).

- 3 Select a search condition. Only pictures that match the search condition will be displayed (tap  or  to view additional search conditions).

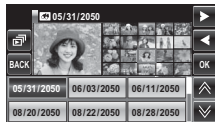

- 4 The large preview to the left of the thumbnails is the current picture. To view the current picture full frame, tap the preview or tap **OK**.

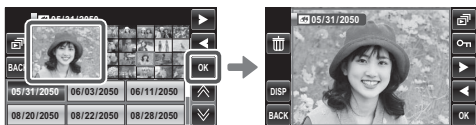

Tap ◀ or ▶ to scroll through the pictures that match the search conditions or tap 📖 to view them in a slide show (📖 89). To delete (🗑️ 57) or protect (🔒 90) the pictures, tap 🗑️ or 🔒 respectively.

- 5 To exit, tap **OK** when the current picture is shown full frame. Tap **OK** to end the search.

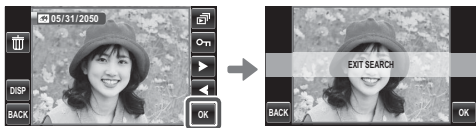

PhotoBook Assist

Create books from your favorite photos.

Creating a PhotoBook



1 Tap the  icon in single-frame view.



- ◆ Photobook assist can also be accessed from the playback menu ( 88).



2 Tap **NEW BOOK**.

3 Tap one of the following to choose pictures for the new book.

- **SELECT FROM ALL:** Choose from all available pictures.
- **SELECT BY IMAGE SEARCH:** Choose from pictures matching selected search conditions ( 58).
- ◆ Neither photographs  or smaller nor movies can be selected for photobooks.

4 Scroll through the images and tap  to select or deselect the current image for inclusion in the book. To display the current image on the cover, tap .

- ◆ The first picture selected becomes the cover image. Tap  to select a different picture for the cover.

5 Tap **MENU** to exit when the book is complete.

6 Tap **COMPLETE PHOTOBOOK** (to select all photos or all photos matching the specified search conditions for the book, choose **SELECT ALL**). The new book will be added to the list in the photobook assist menu.



- ⓘ Books can contain up to 300 pictures.
- ⓘ Books that contain no photos are automatically deleted.

Viewing Photobooks

To view a book, tap it in the photobook assist menu and then tap ◀ and ▶ to scroll through the pictures.

Editing and Deleting Photobooks

Display the photobook and tap **MENU**. The following options will be displayed; select the desired option and follow the on-screen instructions.

- **EDIT**: Edit the book as described in “Creating a PhotoBook” (📖 60).
- **ERASE**: Delete the book.

Photobooks





Photobooks can be copied to a computer using the supplied MyFinePix Studio software.

Edit

To rotate pictures, make collages, or create cropped or resized copies of pictures, tap the  icon in single-frame view.

Tap ▲ or ▼ to scroll through the menu and tap an option to select it.





Option	Description
 COLLAGE	Create collages (📖 63).
 IMAGE ROTATE	Rotate pictures (📖 64).
 CROP	Create cropped copies of pictures (📖 64).
 RESIZE	Create small copies of pictures (📖 65).
 RED EYE REMOVAL	Create copies with reduced red eye (📖 65).





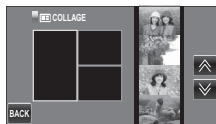

📌 Edit options can also be accessed from the playback menu (📖 89).

COLLAGE

Selecting  **COLLAGE** displays a selection of collage templates.

- 1 Tap the desired template for the collage.
- 2 Tap a frame in the template and then tap a picture at the right side of the display to place it in the selected frame (you can also select a picture first and then tap the target frame). Repeat until the template is filled. If the desired picture is not visible at the right side of the display, tap  or  to view more pictures.



- ◆ To rotate or crop an image for display in a collage, tap its frame in the collage template. Rotation and crop tools will appear at the edges of the display. To rotate the picture, tap . The picture is rotated 90 ° clockwise each time you tap the icon. Tap  or  to zoom the selected picture in or out and tap , , , or  to position it in the frame. Tap **OK** when the operation is complete. Note that depending on the template, you may not be able to rotate or crop the image.



- 3 Tap **OK** to complete the collage.
- 4 Image size options will be displayed. Tap an option to create a collage at the selected size and save it as a new file.

IMAGE ROTATE

This option rotates pictures for display on the camera. It has no effect on pictures displayed on a computer or other device.

- 1 Tap the left and right arrows (◀ and ▶) to select the picture you wish to rotate.
- 2 Tap ↻ to rotate the picture 90° clockwise, ↺ to rotate it 90° counterclockwise.
- 3 Tap **OK**.

The next time the picture is played back, the rotated one will be displayed.

❖ The camera may not be able to rotate pictures created with other devices.

CROP

Create cropped copies of pictures.

- 1 Tap the left and right arrows (◀ and ▶) to select the picture you wish to crop.
- 2 Tap 🔍 or 🔍 to zoom in and out (tap the picture to re-display the zoom icons as needed) and tap ▲, ▼, ◀, or ▶ to scroll the picture until the desired portion is displayed. Higher zoom ratios produce smaller copies.
- 3 Tap **OK** to save the cropped copy to a separate file.



RESIZE

Create small copies of pictures.

- 1 Tap the left and right arrows (◀ and ▶) to select the picture you wish to resize.
- 2 Tap an icon to copy the picture at the selected size. The sizes available vary with the size of the original image.

RED EYE REMOVAL

This option is used with pictures taken using Intelligent Face Detection to create copies that have been processed to remove red eye.



- 1 Tap the left and right arrows (◀ and ▶) to select a picture.
 - 2 Tap **OK** to create a copy with reduced red-eye.
- ❖ Red eye may not be removed if the camera is unable to detect a face or the face is in profile. Results may differ depending on the scene. Red eye can not be removed from pictures that have already been processed using red-eye removal.
 - ❖ The amount of time needed to process the image varies with the number of faces detected.
 - ❖ Copies created with  **RED EYE REMOVAL** are indicated by a  icon during playback.



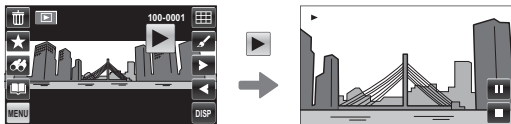





Viewing Panoramas

To view a panorama, display in single-frame view and tap .





Horizontal panoramas are displayed from left to right, vertical panoramas from bottom to top. The following operations can be performed during playback:

Operation	Description
End playback	Tap  to end playback.
Pause playback	Tap  to pause playback. Tap  to resume.

- ❖ Panoramas can be zoomed in and out using gestures in single-frame playback ( 54).
- ❖ When playback is paused, you can drag a finger over the display to scroll the panorama, centered on your finger.
- ❖  panoramas play back in an endless loop ( 36); the playback direction can be controlled by tapping  or  (or  or  in the case of vertical panoramas). The camera will not turn off automatically while playback is in progress ( 98).

Movies

Recording Movies

Press  to shoot a movie. During recording,  **REC** and the time remaining will be displayed and sound will be recorded via the built-in microphone (be careful not to cover the microphone during recording).

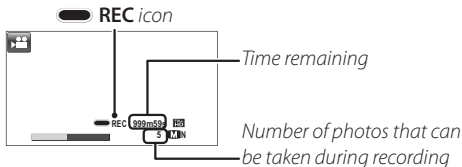



To end recording, press the  button again. Recording ends automatically when the movie reaches maximum length or memory is full.

- ❖ Zoom can be adjusted while recording is in progress.
- ❖ Focus, exposure, and white balance are adjusted automatically throughout recording. The color and brightness of the image may vary from that displayed before recording begins.
- ❖ Sounds made by the camera may be recorded.



Taking Photographs During Recording







Press the shutter button to take a photograph during recording.

- ❖ If  is selected for  **IMAGE SIZE**, the picture will be recorded at size .
- ❖ The photo is saved separately from the movie and does not appear as part of the movie.
- ① Photos can not be taken while a high-speed movie is being recorded.

- ① The indicator lamp lights while movies are being recorded. Do not open the battery chamber during shooting or while the indicator lamp is lit. Failure to observe this precaution could prevent the movie from being played back.
- ① Vertical or horizontal streaks may appear in movies containing very bright subjects. This is normal and does not indicate a malfunction.
- ① The temperature of the camera may rise if it is used to record movies for an extended period or if the ambient temperature is high. This is normal and does not indicate a malfunction.

Movie Frame Size

Before recording, select a frame size using the  **MOVIE MODE** option in the shooting menu ( 84).





Option	Description
 1920 (1920×1080)	Full HD (High Definition).
 1280 (1280×720)	High Definition.
 640 (640×480)	Standard definition.
 640×480 (80 fps)	High speed movie. Sound is not recorded, and focus, exposure, and white balance are not adjusted automatically. Black bands appear at the top and bottom of movies recorded at  320×112 .
 320×240 (160 fps)	
 320×112 (320 fps)	

Viewing Movies



During playback, movies are displayed as shown at right. Tap  to begin playback. The following operations can be performed:

 mode icon



Operation	Description
End playback	Tap  to end playback.
Pause playback	Tap  to pause playback. Tap  to resume.
Adjust speed	Tap  or  to adjust playback speed.

Playback Speed

Tap  or  to adjust playback speed. Speed is shown by the number of arrows (▶ or ◀).

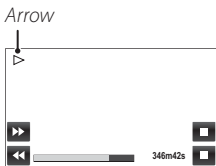

ⓘ Do not cover the speaker during playback.

Connections

Connecting the Camera to High Definition (HD) TVs

An HDMI cable (available from third-party suppliers) can be used to connect the camera to High Definition (HD) devices (playback only). The USB cable can not be used while an HDMI cable is connected.

- 1 Turn the camera off and connect the HDMI cable as shown below.

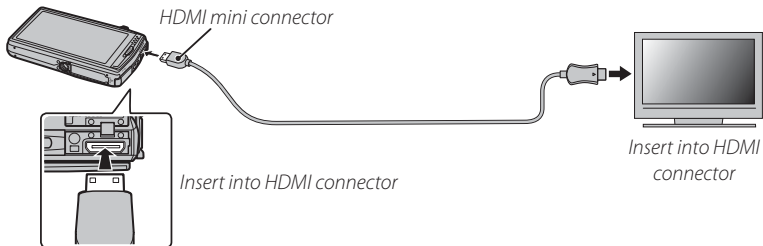

◆ Image quality may drop during movie playback.

- 2 Tune the television to the HDMI input channel. See the documentation supplied with the television for details.

- 3 Press the **HOME** button for about a second to turn the camera on. Only the button icons appear in the camera display; pictures and movies are played back on the TV. Note that the camera volume controls have no effect on sounds played on the TV; use the television volume controls to adjust the volume.

While the camera is connected, pictures can be deleted (📖 57) and rotated (📖 64). You can also view pictures in playback zoom (📖 53), multi-frame playback (📖 55), slide show (📖 89) and photobook (📖 60).

Printing Pictures via USB

If the printer supports PictBridge, the camera can be connected directly to the printer as shown below and pictures can be printed without first being copied to a computer. Note that depending on the printer, not all the functions described below may be supported.



- 1 Connect the supplied USB cable as shown and turn the printer on.

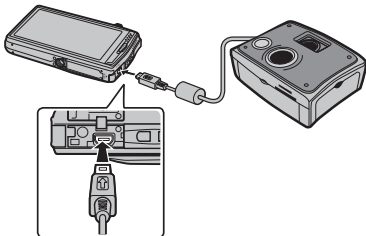

- 2 Press the **HOME** button for about a second to turn the camera on.
- 3 Tap ◀ or ▶ to select a picture you wish to print.
- 4 Tap + or – to choose the number of copies (up to 99).
- 5 Repeat steps 3–4 to select additional pictures. Tap **PRINT** to display a confirmation dialog when settings are complete.

- 6 Tap **OK** to start printing. Printing can be interrupted by tapping **CANCEL**, but note that some printers may not respond immediately. If the printer stops before printing is complete, turn the camera off and then on again.
 - 7 After confirming that **PRINTING** has cleared from the camera display, turn the camera off and disconnect the USB cable.
- ◆ Pictures can be printed from internal memory or a memory card that has been formatted in the camera.
 - ◆ If no pictures are selected, the camera will print one copy of the current picture.
 - ◆ Page size, print quality, and border selections are made using the printer.

Printing the Date of Recording

To print the date of recording on pictures, tap **MENU** in the PictBridge display and select **PRINT WITH DATE**  (to print pictures without the date of recording, select **PRINT WITHOUT DATE**). Some printers do not support date printing. See the printer manual for details.

Viewing Pictures on a Computer

The supplied software can be used to copy pictures to a computer, where they can be stored, viewed, organized, and printed. Before proceeding, install the software as described below. **Do not connect the camera to the computer until installation is complete.**

Windows: Installing MyFinePix Studio

1 Confirm that the computer meets the following system requirements:

	Windows 7 (SP 1)/Windows Vista (SP 2) ¹	Windows XP (SP 3) ¹
CPU	3 GHz Pentium 4 or better (2.4 GHz Core 2 Duo or better) ²	2 GHz Pentium 4 or better (2.4 GHz Core 2 Duo or better) ²
RAM	1 GB or more	512 MB or more (1 GB or more) ²
Free disk space	2 GB or more	
GPU	Supports DirectX 9 or later (recommended)	Supports DirectX 7 or later (required; performance not guaranteed with other GPUs)
Video	1,024 × 768 pixels or more with 24-bit color or better	
Other	<ul style="list-style-type: none">• Built-in USB port recommended. Operation is not guaranteed with other USB ports.• Internet connection (broadband recommended) required to install .NET Framework (if necessary), to use auto update feature, and when performing such tasks as sharing pictures on-line or via e-mail.	

- 1 Other versions of Windows are not supported. Only pre-installed operating systems are supported; operation is not guaranteed on home-built computers or computers that have been upgraded from earlier versions of Windows.
- 2 Recommended when displaying HD movies.

- 2 Start the computer. Log in to an account with administrator privileges before proceeding.
- 3 Exit any applications that may be running and insert the installer CD in a CD-ROM drive.

Windows 7/Windows Vista

If an AutoPlay dialog is displayed, click **SETUP.EXE**. A “User Account Control” dialog will then be displayed; click **Yes** (Windows 7) or **Allow** (Windows Vista).

The installer will start automatically; click **Install MyFinePix Studio** and follow the on-screen instructions to install MyFinePix Studio.

If the Installer Does Not Start Automatically

If the installer does not start automatically, select **Computer** or **My Computer** from the Start menu, then double-click the **FINEPIX** CD icon to open the FINEPIX CD window and double-click **setup** or **SETUP.EXE**.

- 4 If prompted to install Windows Media Player, DirectX, or .NET Framework, follow the on-screen instructions to complete installation.
- 5 Remove the installer CD from the CD-ROM drive when installation is complete. Store the installer CD in a dry location out of direct sunlight in case you need to re-install the software.

Installation is now complete. Proceed to “Connecting the Camera” (📖 78).

Macintosh: Installing FinePixViewer

- 1** Confirm that the computer meets the following system requirements:

CPU	PowerPC or Intel (Core 2 Duo or better)*
OS	Pre-installed copies of Mac OS X version 10.3.9–10.6 (visit http://www.fujifilm.com/support/digital_cameras/compatibility/ for more information)
RAM	256 MB or more (1 GB or more)*
Free disk space	A minimum of 200 MB required for installation with 400 MB available when FinePixViewer is running
Video	800 × 600 pixels or more with thousands of colors or better
Other	Built-in USB port recommended. Operation is not guaranteed with other USB ports.

* Recommended when displaying HD movies.

- 2** After starting the computer and quitting any applications that may be running, insert the installer CD in a CD-ROM drive and double-click **Installer for Mac OS X**.
- 3** An installer dialog will be displayed; click **Installing FinePixViewer** to start installation. Enter an administrator name and password when prompted and click **OK**, then follow the on-screen instructions to install FinePixViewer. Click **Exit** to quit the installer when installation is complete.

4 Remove the installer CD from the CD-ROM drive. Note that you may be unable to remove the CD if Safari is running; if necessary, quit Safari before removing the CD. Store the installer CD in a dry location out of direct sunlight in case you need to re-install the software.

5 Mac OS X 10.5 or earlier: Open the “Applications” folder, start Image Capture, and select **Preferences...** from the Image Capture application menu. The Image Capture preferences dialog will be displayed; choose **Other...** in the **When a camera is connected, open** menu, then select **FPVBridge** in the “Applications/FinePixViewer” folder and click **Open**. Quit Image Capture.

Mac OS X 10.6: Connect the camera and turn it on. Open the “Applications” folder and start Image Capture. The camera will be listed under **DEVICES**; select the camera and choose **FPVBridge** from the **Connecting this camera opens** menu and click **Choose**. Quit Image Capture.

Installation is now complete. Proceed to “Connecting the Camera” (📖 78).

Connecting the Camera

- 1** If the pictures you wish to copy are stored on a memory card, insert the card into the camera.
 - ◆ Windows users may require the Windows CD when starting the software for the first time.
 - Ⓢ Loss of power during transfer could result in loss of data or damage to internal memory or the memory card. Charge the battery before connecting the camera.
- 2** Turn the camera off and connect the supplied USB cable as shown, making sure the connectors are fully inserted. Connect the camera directly to the computer; do not use a USB hub or keyboard.

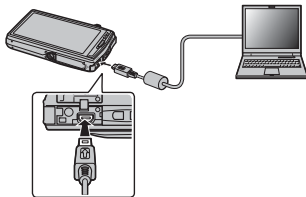

- 3** Press the **HOME** button for about a second to turn the camera on. MyFinePix Studio or FinePixViewer will start automatically; follow the on-screen instructions to copy pictures to the computer. To exit without copying pictures, click **Cancel**.
 - ◆ If the software does not start automatically, it may not be correctly installed. Disconnect the camera and reinstall the software.

For more information on using the supplied software, start the application and select the appropriate option from the **Help** menu.

- ❗ If a memory card containing a large number of images is inserted, there may be a delay before the software starts and you may be unable to import or save images. Use a memory card reader to transfer pictures.
- ❗ Make sure that the computer does not display a message stating that copying is in progress and that the indicator lamp is out before turning the camera off or disconnecting the USB cable (if the number of images copied is very large, the indicator lamp may remain lit after the message has cleared from the computer display). Failure to observe this precaution could result in loss of data or damage to internal memory or the memory card.
- ❗ Disconnect the camera before inserting or removing memory cards.
- ❗ In some cases, it may not be possible to access pictures saved to a network server using the supplied software in the same way as on a standalone computer.
- ❗ The user bears all applicable fees charged by the phone company or Internet service provider when using services that require an Internet connection.

Disconnecting the Camera

After confirming that the indicator lamp is out, turn the camera off and disconnect the USB cable.

Uninstalling the Supplied Software

Only uninstall the supplied software when it is no longer required or before beginning reinstallation. After quitting the software and disconnecting the camera, drag the “FinePixViewer” folder from “Applications” into the Trash and select **Empty Trash** in the **Finder** menu (Macintosh), or open the control panel and use “Programs and Features” (Windows 7/Windows Vista) or “Add or Remove Programs” (Windows XP) to uninstall MyFinePix Studio. Under Windows, one or more confirmation dialogs may be displayed; read the contents carefully before clicking **OK**.

Menus

Using the Menus: Shooting Mode

Use the shooting menu to adjust shooting settings. The options available vary with the shooting mode selected.

Using the Shooting Menu

- 1 To view the shooting menu, tap the **MENU** icon when the camera is in shooting mode.

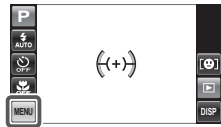

- 2 Tap the icon for the desired menu item.
- 3 Tap the desired option.

Shooting Menu Options**EXP. COMPENSATION**(defaults to **0**)

Adjust exposure (☰ 40).

ISO ISO(defaults to **AUTO**)

Control the camera's sensitivity to light. Higher values can reduce blur; note, however, that mottling may appear in pictures taken at high sensitivities.



Option	Description
AUTO	Sensitivity is adjusted automatically in response to shooting conditions.
AUTO (3200) / AUTO (1600) / AUTO (800) / AUTO (400)	As above, except that sensitivity will not be raised above the value in parentheses.
6400 / 3200 / 1600 / 800 / 400 / 200 / 100	Sensitivity is set to the specified value, which is shown in the display.

IMAGE SIZE

(defaults to **L** 4:3)

Choose the image size and aspect ratio at which pictures are recorded. Large pictures can be printed at large sizes with no drop in quality, while small pictures require less memory, allowing more pictures to be recorded.



Size Versus Aspect Ratio

Size

Option	Prints at sizes up to
L	34 × 25 cm (13.5 × 10 in.)
M	24 × 18 cm (9.5 × 7 in.)
S	17 × 13 cm (7 × 5 in.)

Aspect ratio

4:3: Pictures have the same proportions as the camera display.

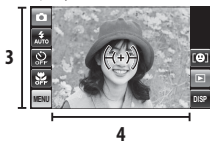

16:9: Suited for display on High Definition (HD) devices.

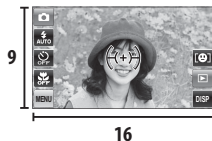

IMAGE QUALITY

(defaults to **FINE**)

Choose how much image files are compressed.

Option	Description
FINE	Low compression. Select for higher image quality.
NORMAL	High compression. Select this option to store more pictures.

MOVIE MODE(defaults to **FHD 1920**)

Choose a movie frame size (📖 68).

DYNAMIC RANGE(defaults to **AUTO**)

Control contrast. Higher values are recommended for scenes that include both sunlight and deep shade or for increased contrast with such subjects as sunlight on water, brightly-lit autumn leaves, portraits taken against a blue sky, and white objects or people wearing white; note, however, that mottling may appear in pictures taken at higher values. If **AUTO** is selected, the camera will automatically select values between 100% and 400% in response to shooting conditions.

Option	Description	
AUTO		100 100% Increase contrast when shooting indoors or under overcast skies.
		200 200%
		400 400%
800 800%	Reduce loss of detail in highlights and shadows when photographing high-contrast scenes.	
1600 1600%		

◆ **1600 1600%** and **800 800%** are available only when **D-RANGE PRIORITY** is selected in **EXR** mode and an option other than **Velvia/VIVID** is selected for **FILM SIMULATION**.







FILM SIMULATION(defaults to **STD**)

Simulate the effects of different types of film, including sepia and black-and-white.

Option	Description
STD PROVIA/STANDARD	Standard color reproduction. Suited to a wide range of subjects, from portraits to landscapes.
Velvia/VIVID	A high-contrast palette of saturated colors, suited to nature photographs.
B&W	Take pictures in black and white.
SEPIA SEPIA	Take pictures in sepia.

WB WHITE BALANCE(defaults to **AUTO**)

For natural colors, choose a setting that matches the light source.

Option	Description
AUTO	White balance adjusted automatically.
	For subjects in direct sunlight.
	For subjects in the shade.
	Use under "daylight" fluorescent lights.
	Use under "warm white" fluorescent lights.
	Use under "cool white" fluorescent lights.
	Use under incandescent lighting.

- ◆ Auto white balance is used with the flash.
- ◆ Results vary with shooting conditions. Play pictures back after shooting to check colors in the display.

CONTINUOUS SHOOTING SETUP(defaults to **OFF**)



Capture motion in a series of pictures (🗨 46).

FACE DETECTION

Choose whether the camera automatically detects and sets focus and exposure for human portrait subjects (🗨 45).

AF MODE



This option controls how the camera selects the focus area for photographs. Regardless of the option selected, the camera will focus on the subject in the center of the frame when macro mode is on.

Option	Description
 CENTER	The camera focuses on the subject in the center of the frame.
 MULTI	When the shutter button is pressed halfway, the camera detects high-contrast subjects near the center of the frame and selects the focus area automatically.
 TOUCH & TRACK	Touch the subject in the center of the display. Focus will track the subject as it moves through the frame.

- Note that in  mode, the camera focuses continuously, increasing the drain on the battery, and that the sound of the camera focusing may be audible.

MOVIE AF MODE(defaults to )

This option controls how the camera selects the focus area for movies.

Option	Description
 CENTER	The camera focuses on the subject in the center of the frame.
 CONTINUOUS	The camera continuously adjusts focus to reflect changes in the distance to the subject in the focus frame.

- Note that in  mode, the camera focuses continuously, increasing the drain on the battery, and that the sound of the camera focusing may be audible.

ADVANCED ANTI BLUR(defaults to **ON**)

Select **ON** to enable advanced anti blur in  mode (🗨 31).

INTELLIGENT SHARPNESS(defaults to **OFF**)

Select **ON** to process photos digitally for sharp, super high-resolution results.

- ◆ The time needed to record images increases.
- ◆ The effects are not visible in the display during shooting.
- ◆ Intelligent sharpness may turn off automatically in some modes.
- ◆ This option has no effect on photos taken in continuous mode.

SET-UP

Display the setup menu (🗨 94).

Using the Menus: Playback Mode

The playback menu is used to manage the pictures in internal memory or on the memory card.

Using the Playback Menu

1 To view the playback menu, tap the **MENU** icon during playback.



2 Tap the icon for the desired menu item.

3 Tap the desired option.

Playback Menu Options

PHOTOBOOK ASSIST

Create books from your favorite photos ( 60).

FAVORITES

Rate pictures ( 52).

PICTURE COMPARE





Compare two pictures side-by-side. Tap a frame to highlight it and scroll left or right or tap  or  to choose the picture shown. Tap  to zoom in on the highlighted picture or tap  to delete it. To exit to single-frame playback, tap **BACK**.

IMAGE SEARCH



Search for pictures (📖 58).



EDIT

Retouch pictures (📖 62).

SLIDE SHOW

View pictures in an automated slide show.

- 1 Tap  to view the slide show in “wide” (landscape) orientation or  to view the show in “tall” (portrait) orientation.
- 2 Choose the background music and display format and start the slide show.

Option	Description
ZOOM & MOTION	The camera slowly zooms out from each frame during playback.
PHOTOBOOK	Select FADE-IN for fade transitions between frames, PHOTOBOOK for a page-turn transitions.
NORMAL	
FADE-IN	
NORMAL 	As above, except that camera automatically zooms in on faces selected with Intelligent Face detection.
FADE-IN 	
MULTIPLE	Display several pictures at once.
SELECT BGM	Choose background music.





- ◆ The camera will not turn off automatically while a slide show is in progress.
- ◆ To exit the slide show, tap the display and tap **STOP**.

PROTECT

Protect pictures from accidental deletion.

1 Tap  in the playback menu.

2 Tap one of the following options:

- **FRAME:** Protect selected pictures. Tap  or  to select the desired picture. Tap  to protect the picture. If the picture is already protected, tapping  will remove protection from the image.
- **SET ALL:** Protect all pictures.
- **RESET ALL:** Remove protection from all pictures.

3 Tap **BACK** to exit when the operation is complete.



① Protected pictures will be deleted when the memory card or internal memory is formatted (📖 97).

COPY



Copy pictures from internal memory to a memory card.

1 Tap **COPY** in the playback menu.

2 Tap one of the following options:

-  **INTERNAL MEMORY** →  **CARD:** Copy pictures from internal memory to a memory card.
-  **CARD** →  **INTERNAL MEMORY:** Copy pictures from a memory card to internal memory.

3 Select one of the following:

- **FRAME:** Copy selected pictures. Tap  or  to view pictures.
- **ALL FRAMES:** Copy all pictures.

4 Tap **OK** to copy the current picture.

💡 Copying ends when the destination is full.

 **ERASE FACE RECOG.**

Remove face recognition links from the current image. When this option is selected, the camera will zoom in on an area in the current picture that it has matched with a face in the face recognition database. If the match is not correct, tap **OK** to remove the link to the face recognition database.

 Face recognition links can not be removed from copies with a size of **640**.

 **ERASE**

Delete all or selected pictures ( 57).



MARK FOR UPLOAD TO

Select pictures for upload to YouTube or Facebook using MyFinePix Studio (Windows only).

■ **Selecting Pictures for Upload**

1 Tap  in the playback menu.

2 Tap **YouTube** to select movies for upload to YouTube, **FACEBOOK** to select photos and movies for upload to Facebook.

3 Tap  or  to display pictures and tap **OK** to select or deselect. Tap **BACK** to exit when all the desired pictures are selected.

◆ Only movies can be selected for upload to YouTube.

◆ During playback, selected pictures are indicated by  **YouTube** or  **FACEBOOK** icons.

■ **RESET ALL: Deselecting All Pictures**

To deselect all pictures, tap **RESET ALL** and tap **OK**, or tap **BACK** to exit without changing picture status.

If the number of pictures affected is very large, a message will be displayed while the operation is in progress. Tap **BACK** to exit before the operation is complete.

■ **Uploading Pictures (Windows Only)**

Selected pictures can be uploaded using MyFinePix Studio.

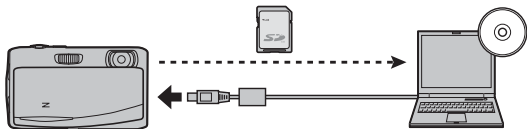

For information on installing MyFinePix Studio and connecting the camera to a computer, see "Viewing Pictures on a Computer" (📖 74).

SET SET-UP

Display the setup menu (📖 94).

The Setup Menu

Using the Setup Menu





- 1 Tap the **MENU** icon to display the menu for the current mode.
- 2 Tap **SET (SET-UP)**.
- 3 Tap ▲ or ▼ to display the desired menu item and tap to select.
- 4 Tap the desired option.

Setup Menu Options

DUAL IS MODE

(defaults to )

Choose from the following image stabilization options:

Option	Description
 CONTINUOUS + MOTION	Image stabilization on. If + MOTION is selected, the camera will adjust shutter speed to reduce motion blur when a moving objects are detected.
 CONTINUOUS	
 SHOOTING + MOTION	As above, except that image stabilization is performed only when the shutter button is pressed halfway or the shutter is released.
 SHOOTING ONLY	
OFF	Image stabilization off. Choose this option when using a tripod.

- ◆ + **MOTION** has no effect when sensitivity is set to a fixed value, and may also be unavailable at some other combinations of settings. The effect may vary with lighting conditions and the speed at which the object is moving.

SILENT MODE

(defaults to **OFF**)

Select **ON** to disable the speaker, flash, and illuminator in situations in which camera sounds or lights may be unwelcome (note that the flash will still fire in  mode).

INTELLIGENT DIGITAL ZOOM(defaults to **OFF**)

If **ON** is selected, selecting  at the maximum optical zoom position triggers intelligent digital zoom, further magnifying the image while processing it for sharp, high-resolution results.

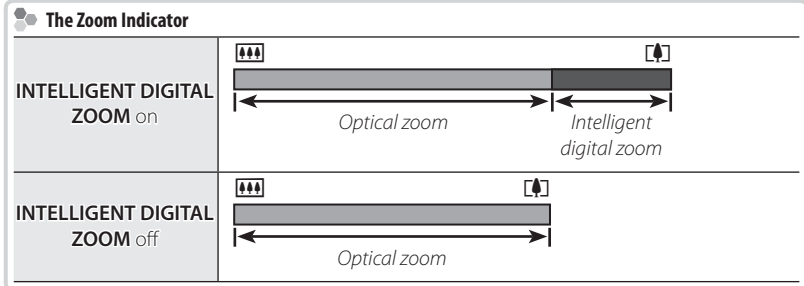

- ◆ Intelligent digital zoom may end when another mode is selected.
- ◆ Intelligent digital zoom may sometimes produce lower quality images than optical zoom.
- ◆ The time needed to record images increases.
- ◆ The effects are not visible in the display during shooting.
- ◆ Intelligent digital zoom is not available in continuous mode or during movie recording.

BEST FRAMING(defaults to **OFF**)

Choose **ON** to display a framing guide.

SAVE ORG IMAGE(defaults to **OFF**)

Choose **ON** to save unprocessed copies of seamless  panoramas or pictures taken using

RED EYE REMOVAL

IMAGE DISP. (defaults to **1.5 SEC**)

Choose how long pictures are displayed in the LCD monitor after shooting.

Option	Description
3 SEC	Pictures are displayed for three seconds (3 SEC) or 1.5 seconds (1.5 SEC).
1.5 SEC	Colors may differ slightly from those in the final image.
ZOOM (CONTINUOUS)	Pictures are displayed until you tap OK .
OFF	Pictures are not displayed after shooting.

❖ **OFF** has no effect in continuous shooting mode.



FRAME NO. (defaults to **CONT.**)

New pictures are stored in image files named using a four-digit file number assigned by adding one to the last file number used. The file number is displayed during playback as shown at right.

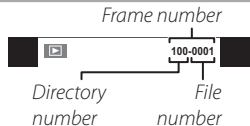
 **FRAME NO.** controls whether file numbering is reset to 0001 when a new memory card is inserted or the current memory card or internal memory is formatted.



Option	Description
CONTINUOUS	Numbering continues from the last file number used or the first available file number, whichever is higher. Choose this option to reduce the number of pictures with duplicate file names.
RENEW	Numbering is reset to 0001 after formatting or when a new memory card is inserted.

- ❖ If the frame number reaches 999-9999, the shutter release will be disabled (📖 113).
- ❖ Selecting  **RESET** (📖 100) sets  **FRAME NO.** to **CONTINUOUS** but does not reset the file number.
- ❖ Frame numbers for pictures taken with other cameras may differ.

ILLUMINATION(defaults to **ON**)

If **ON** is selected, the illuminator will light when the camera is turned on and after pictures are taken.

DATE/TIME

Set the camera clock (🗨 21).

VOLUME

Adjust volume for the shutter, controls, and playback. Tap an option and choose a volume, either by selecting an option in a menu (shutter and control volume) or by tapping ▲ and ▼ to choose a setting between **OFF** and **10** (playback volume). Tap **OK** when settings are complete.

SOUND

Choose the sounds used for the shutter, at startup, and for camera controls. Tap an option and then tap an icon to choose a sound. Tap **OK** when settings are complete.

LCD BRIGHTNESS(defaults to **0**)

Control the brightness of the display.

FORMAT

If a memory card is inserted in the camera, this option will format the memory card. If no memory card is inserted, this option will format internal memory. Tap **OK** to begin formatting.

- ⓘ All data—including protected pictures—will be deleted from the memory card or internal memory. Be sure important files have been copied to a computer or other storage device.
- ⓘ Do not open the battery-chamber cover during formatting.

言語/LANG.

(defaults to **ENGLISH**)

Choose a language ( 122).

AUTO POWER OFF

(defaults to **2 MIN**)

Choose the length of time before the camera turns off automatically when no operations are performed. Shorter times increase battery life; if **OFF** is selected, the camera must be turned off manually. Note that in some situations the camera turns off automatically even when **OFF** is selected.

TIME DIFFERENCE





(defaults to )

Switch the camera clock instantly from your home time zone to the local time at your destination when traveling. To specify the difference between local time and your home time zone:

1 Tap  **LOCAL**.

2 Tap the +, -, ▲, and ▼ icons to choose the time difference. The minimum increment is 15 minutes. Tap **OK** when settings are complete.

To switch between local time and your home time zone, tap  **LOCAL** or  **HOME**.

Option	Description
 HOME	Switch to the time currently selected for  DATE/TIME ( 97).
 LOCAL	Switch to local time. If this option is selected,  and the time and date will be displayed in yellow for three seconds each time the camera is turned on.

👁️ RED EYE REMOVAL (defaults to **ON**)

Choose **ON** to remove red-eye effects caused by the flash when shooting with Intelligent Face Detection.

🔍 Red-eye reduction is performed only when a face is detected.

📺 AUTOROTATE PB (defaults to **ON**)

Choose **ON** to automatically rotate “tall” (portrait-orientation) pictures during playback.

🎨 BACKGROUND COLOR

Choose a color scheme.

📷 POWER MANAGEMENT (defaults to **📷**)

Optimize camera performance for increased battery life or display quality.

Option	Description
📷 POWER SAVE	Reduces display refresh rate. The display dims to save power if no operations are performed for a short period, but can be restored by operating camera controls or tapping the display. Select this option to save power.
📺 CLEAR DISPLAY	Choose this option for a brighter, higher quality display and for a longer delay before the monitor dims to save power.

🔍 **📷 POWER SAVE** does not take effect when Intelligent Face Detection is on.

RESET

Tap **OK** to reset all settings except  **DATE/TIME** and  **TIME DIFFERENCE** to default values.

CALIBRATION

Calibrate the touch panel. Using your finger, tap the “+” symbols in the order (if you tap too far from the correct symbol, an error will be displayed; tap the correct symbol again) and tap **OK**.

VERSION INFO

Display the current firmware version.

Technical Notes

Optional Accessories

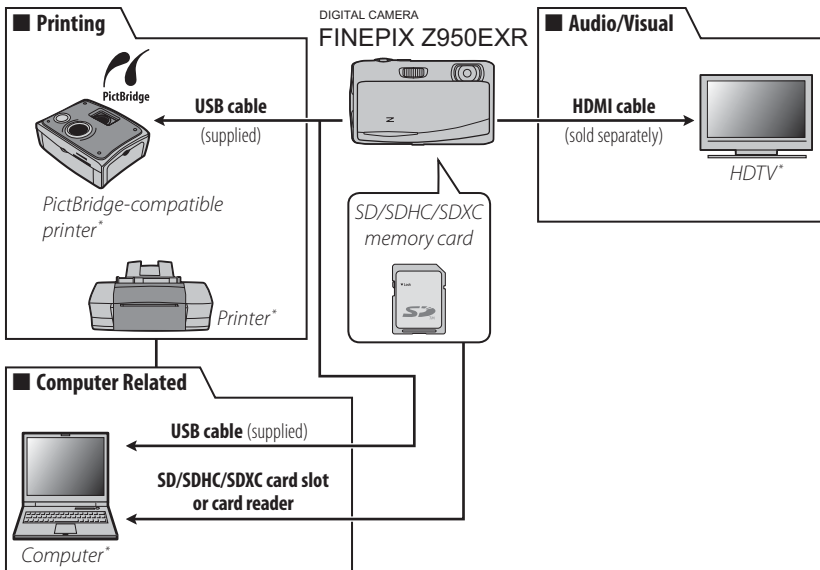

The camera supports a wide range of accessories from FUJIFILM and other manufacturers.



* Available separately.

Accessories from FUJIFILM

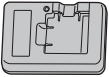
The following optional accessories are available from FUJIFILM. For the latest information on the accessories available in your region, check with your local FUJIFILM representative or visit http://www.fujifilm.com/products/digital_cameras/index.html.

Rechargeable Li-ion batteries	NP-45A: Additional large-capacity NP-45A rechargeable batteries can be purchased as required.	
Battery chargers	BC-45W: Replacement battery chargers can be purchased as required. The BC-45W charges an NP-45A battery in about 120 minutes at +20 °C (+68 °F).	
AC power adapters	AC-5VX (requires CP-45 DC coupler): Use for extended playback or when copying pictures to a computer (shape of adapter and plug vary with region of sale).	
DC couplers	CP-45: Connect the AC-5VX to the camera.	

Caring for the Camera

To ensure continued enjoyment of the product, observe the following precautions.

Storage and Use

If the camera will not be used for an extended period, remove the battery and memory card. Do not store or use the camera in locations that are:

- exposed to rain, steam, or smoke
- very humid or extremely dusty
- exposed to direct sunlight or very high temperatures, such as in a closed vehicle on a sunny day
- extremely cold
- subject to strong vibration
- exposed to strong magnetic fields, such as near a broadcasting antenna, power line, radar emitter, motor, transformer, or magnet
- in contact with volatile chemicals such as pesticides
- next to rubber or vinyl products

■ **Water and Sand**

Exposure to water and sand can also damage the camera and its internal circuitry and mechanisms. When using the camera at the beach or seaside, avoid exposing the camera to water or sand. Do not place the camera on a wet surface.

■ **Condensation**

Sudden increases in temperature, such as occur when entering a heated building on a cold day, can cause condensation inside the camera. If this occurs, turn the camera off and wait an hour before turning it on again. If condensation forms on the memory card, remove the card and wait for the condensation to dissipate.

Cleaning

Use a blower to remove dust from the lens and LCD monitor, then gently wipe with a soft, dry cloth. Any remaining stains can be removed by wiping gently with a piece of FUJIFILM lens-cleaning paper to which a small amount of lens-cleaning fluid has been applied. Care should be taken to avoid scratching the lens or LCD monitor. The camera body can be cleaned with a soft, dry cloth. Do not use alcohol, thinner, or other volatile chemicals.

Traveling

Keep the camera in your carry-on baggage. Checked baggage may suffer violent shocks that could damage the camera.

Troubleshooting

Problems and Solutions

Power and Battery

Problem	Solution
The camera does not turn on.	<ul style="list-style-type: none">• The battery is exhausted: Charge the battery (📖 12) or insert a fully-charged spare battery (📖 14).• The battery is inserted incorrectly: Reinsert in the correct orientation (📖 14).• The battery-chamber cover is not latched: Latch the battery-chamber cover (📖 15).• The AC power adapter and DC coupler are connected incorrectly: Reconnect the AC power adapter and DC coupler.
The battery runs down quickly.	<ul style="list-style-type: none">• The battery is cold: Warm the battery by placing it in a pocket or other warm place and reinsert it in the camera immediately before taking a picture.• There is dirt on the battery terminals: Clean the terminals with a soft, dry cloth.• 📷 CLEAR DISPLAY is selected for 📷 POWER MANAGEMENT: Select 📷 POWER SAVE to reduce the drain on the battery (📖 99).• EXR is selected for shooting mode: Select 📷 mode to reduce the drain on the battery (📖 29).• 📷 TOUCH & TRACK is selected for 📷 AF MODE or 📷 CONTINUOUS selected for 📷 MOVIE AF MODE: Select a different AF mode (📖 86).• The battery has been charged many times: The battery has reached the end of its charging life. Purchase a new battery.
The camera turns off suddenly.	<ul style="list-style-type: none">• The battery is exhausted: Charge the battery (📖 12) or insert a fully-charged spare battery (📖 14).• The AC power adapter or DC coupler has been disconnected: Reconnect the AC power adapter and DC coupler.







Problem	Solution
Charging does not start.	Reinsert the battery in the correct orientation and make sure that the charger is plugged in (📖 12).
Charging is slow.	Charge the battery at room temperature (📖 vi).
The charging lamp lights, but the battery does not charge.	<ul style="list-style-type: none"> • There is dirt on the battery terminals: Clean the terminals with a soft, dry cloth. • The battery has been charged many times: The battery has reached the end of its charging life. Purchase a new battery. If the battery still fails to charge, contact your FUJIFILM dealer. • The battery is too hot or too cold: Wait for the battery temperature to stabilize (📖 124).



Menus and Displays

Problem	Solution
Menus and displays are not in English.	Select ENGLISH for  言語/LANG. (📖 21, 98).







Shooting

Problem	Solution
No picture is taken when the shutter button is pressed.	<ul style="list-style-type: none"> • Memory is full: Insert a new memory card or delete pictures (📖 15, 57). • Memory is not formatted: Format the memory card or internal memory (📖 97). • There is dirt on the memory card contacts: Clean the contacts with a soft, dry cloth. • The memory card is damaged: Insert a new memory card (📖 15). • The battery is exhausted: Charge the battery (📖 12) or insert a fully-charged spare battery (📖 14). • The camera has turned off automatically: Turn the camera on (📖 19). • The indicator lamp was orange when you attempted to record a panorama: Wait until the indicator lamps turns off (📖 3).
The LCD monitor goes dark after shooting.	The LCD monitor may darken while the flash charges. Wait for the flash to charge (📖 41).



Problem	Solution
The camera does not focus.	<ul style="list-style-type: none"> • The subject is close to the camera: Select macro mode (📖 44). • The subject is far away from the camera: Cancel macro mode (📖 44). • The subject is not suited to autofocus: Use focus lock (📖 38).
Pictures are not the same size	If  is selected for  IMAGE SIZE in  mode, the camera will optimize not only sensitivity and other settings, but also image size. To record all pictures at the same size, choose P (PROGRAM AE) or  in the shooting mode or select another option for  IMAGE SIZE (📖 83).
Macro mode is not available	Choose a different shooting mode (📖 29).
Intelligent Face Detection is not available.	<ul style="list-style-type: none"> • Intelligent Face Detection is not available in the current shooting mode: Choose a different shooting mode (📖 29). •  TOUCH & TRACK is selected for  AF MODE: Select a different AF mode (📖 86).
No face is detected.	<ul style="list-style-type: none"> • The subject's face is obscured by sunglasses, a hat, long hair, or other objects: Remove the obstructions. • The subject's face occupies only a small area of the frame: Change the composition so that the subject's face occupies a larger area of the frame (📖 38). • The subject's head is tilted or horizontal: Ask the subject to hold their head straight. • The camera is tilted: Keep the camera level (📖 25). • The subject's face is poorly lit: Shoot in bright light.
Wrong subject is selected.	The selected subject is closer to the center of the frame than the main subject. Recompose the picture or turn face detection off and frame the picture using focus lock (📖 38).

Problem	Solution
The flash does not fire.	<ul style="list-style-type: none"> • The flash is not available in the current shooting mode: Choose a different shooting mode (📖 29). • The battery is exhausted: Charge the battery (📖 12) or insert a fully-charged spare battery (📖 14). • The camera is in continuous mode: Select OFF for  CONTINUOUS SHOOTING SETUP (📖 46). • The camera is in silent mode: Turn silent mode off (📖 94). • The flash is off (🔇): Choose a different flash mode (📖 41).
Some flash modes are not available.	<ul style="list-style-type: none"> • The desired flash mode is not available in the current shooting mode: Choose a different shooting mode (📖 29). • The camera is in silent mode: Turn silent mode off (📖 94).
The flash does not fully light the subject.	<ul style="list-style-type: none"> • The subject is not in range of the flash: Position the subject in range of the flash (📖 122). • The flash window is obstructed: Hold the camera correctly (📖 25).
Pictures are blurred.	<ul style="list-style-type: none"> • The lens is dirty: Clean the lens (📖 104). • The lens is blocked: Keep objects away from the lens (📖 25). • !AF is displayed during shooting and the focus frame is displayed in red: Check focus before shooting (📖 111). • 🔆 is displayed during shooting: Use the flash or a tripod (📖 42).
Pictures are mottled.	<ul style="list-style-type: none"> • A slow shutter speed is selected at high temperatures: This is normal and does not indicate a malfunction. • The camera has been used continuously at high temperatures or a temperature warning is displayed: Turn the camera off and wait for it to cool down.
Pictures are not recorded.	<p>Power was interrupted during shooting. Before connecting the AC power adapter or DC coupler, turn the camera off. Leaving the camera on can result in corrupted files or damage to the memory card or internal memory.</p>
Sounds made by the camera are recorded with movies.	<ul style="list-style-type: none"> •  CONTINUOUS is selected for  MOVIE AF MODE: Select a different AF mode (📖 86). • Zoom was adjusted during shooting: Do not adjust zoom during shooting. • Intelligent Face Detection is on: Turn Intelligent Face Detection off (📖 45).

Playback

Problem	Solution
Pictures are grainy.	The pictures were taken with a different make or model of camera.
Playback zoom is unavailable.	The pictures were created using  RESIZE or with a different make or model of camera.
No sound in movie playback.	<ul style="list-style-type: none"> • Playback volume is too low: Adjust playback volume ( 97). • The microphone was obstructed: Hold the camera correctly during recording ( 25, 67). • The speaker is obstructed: Hold the camera correctly during playback ( 69).
Selected pictures are not deleted.	Some of the pictures selected for deletion are protected. Remove protection using the device with which it was originally applied ( 90).
File numbering is unexpectedly reset.	The battery-chamber cover was opened while the camera was on. Turn the camera off before opening the battery-chamber cover ( 19).





Connections/Miscellaneous



Problem	Solution
No picture or sound.	<ul style="list-style-type: none"> • The camera is not properly connected: Connect the camera properly ( 70). • An HDMI cable was connected during movie playback: Connect the camera once movie playback has ended. • Input on the television is set to "TV": Set input to "HDMI". • The volume on the TV is too low: Adjust the volume.
The computer does not recognize the camera.	Be sure the camera and computer are correctly connected ( 78).

Problem	Solution
Pictures can not be printed.	<ul style="list-style-type: none"> • The camera is not properly connected: Connect the camera correctly (📖 72). • The printer is off: Turn the printer on.
Only one copy is printed/ the date is not printed.	The printer is not PictBridge compatible.
The camera is unre- sponsive.	<ul style="list-style-type: none"> • Temporary camera malfunction: Remove and reinsert the battery (📖 14) or disconnect and reconnect the AC power adapter/DC coupler. • The battery is exhausted: Charge the battery (📖 12) or insert a fully-charged spare battery (📖 14).
The camera does not function as expected.	Remove and reinsert the battery (📖 14) or disconnect and reconnect the AC power adapter/DC coupler. If the problem persists, contact your FUJIFILM dealer.
I want to use an AC power adapter and DC coupler overseas.	Check the label on the AC power adapter. The AC power adapter can be used with voltages of 100 – 240V. Consult your travel agent for information on plug adapters.
No sound.	Turn silent mode off (📖 94).
The camera does not re- spond to the touch panel, or does not perform the expected action when the touch panel is used.	<ul style="list-style-type: none"> • The touch panel requires calibration: Calibrate the touch panel (📖 100). • The hand that is holding the camera is touching the panel: Adjust your grip so that the hand that is holding the camera is not touching the panel.











Warning Messages and Displays

The following warnings are displayed in the LCD monitor:

Warning	Description
 (red)	Low battery. Charge the battery (📖 12) or insert a fully-charged spare battery (📖 14).
 (blinks red)	Battery exhausted. Charge the battery (📖 12) or insert a fully-charged spare battery (📖 14).
	Slow shutter speed. Pictures may be blurred; use the flash or a tripod.
!AF (displayed in red with red focus frame)	The camera can not focus. Try one of the following solutions: <ul style="list-style-type: none">• Use focus lock to focus on another subject at the same distance, then recompose the picture (📖 38).• Use macro mode to focus when taking close-ups (📖 44).
Aperture or shutter speed displayed in red	The subject is too bright or too dark and the picture will be over- or under-exposed. If the subject is dark, use the flash (📖 41).
LENS COVER	Attempted to take photograph with lens cover closed. Open lens cover before taking photographs.
FOCUS ERROR	Camera malfunction. Turn the camera off and then on again. If the message persists, contact a FUJIFILM dealer.
LENS CONTROL ERROR	
	Turn the camera off and wait for it to cool. If no action is taken, the camera will turn off automatically.

Warning	Description
CARD NOT INITIALIZED	<ul style="list-style-type: none"> • The memory card or internal memory is not formatted or the memory card was formatted in a computer or other device: Format the memory card or internal memory using the  FORMAT option in the camera setup menu (📖 97). • The memory card contacts require cleaning: Clean the contacts with a soft, dry cloth. If the message is repeated, format the card (📖 97). If the message persists, replace the card. • Camera malfunction: Contact a FUJIFILM dealer.
PROTECTED CARD	The memory card is locked. Unlock the card (📖 15).
BUSY	The memory card is incorrectly formatted. Use the camera to format the card (📖 97).
CARD ERROR	The memory card is not formatted for use in the camera. Format the card (📖 97).
	The memory card contacts require cleaning or the memory card is damaged. Clean the contacts with a soft, dry cloth. If the message is repeated, format the card (📖 97). If the message persists, replace the card.
	Incompatible memory card. Use a compatible card (📖 17).
	Camera malfunction. Contact a FUJIFILM dealer.
 MEMORY FULL	The memory card or internal memory is full and pictures can not be recorded or copied. Delete pictures or insert a memory card with more free space.
 MEMORY FULL	
INTERNAL MEMORY IS FULL INSERT A NEW CARD	

Warning	Description
WRITE ERROR	<ul style="list-style-type: none"> • Memory card error or connection error: Reinsert the card or turn the camera off and then on again. If the message persists, contact a FUJIFILM dealer. • Not enough memory remaining to record additional pictures: Delete pictures or insert a memory card with more free space. • The memory card or internal memory is not formatted: Format the memory card or internal memory (📖 97).
READ ERROR	<ul style="list-style-type: none"> • The file is corrupt or was not created with the camera: The file can not be viewed. • The memory card contacts require cleaning: Clean the contacts with a soft, dry cloth. If the message is repeated, format the card (📖 97). If the message persists, replace the card. • Camera malfunction: Contact a FUJIFILM dealer.
FRAME NO. FULL	<p>The camera has run out of frame numbers (current frame number is 999-9999). Format the memory card and select RENEW for 📷 FRAME NO. Take a picture to reset frame numbering to 100-0001, then select CONTINUOUS for 📷 FRAME NO. (📖 96).</p>
DEACTIVATE SILENT MODE	<p>An attempt was made to adjust the volume with the camera in silent mode. Exit silent mode before adjusting the volume (📖 94).</p>
TOO MANY FRAMES	<ul style="list-style-type: none"> • A search has returned more than 30,000 results (or more than 4,999 for BY DATE): Choose a search that returns fewer results. • You have attempted to create collages with a total of over 30,000 images: No further collages can be created until you have deleted files or inserted a new memory card. • More than 999 images are selected for deletion: Choose fewer images.
PROTECTED FRAME	<p>An attempt was made to delete or rotate to a protected picture. Remove protection and try again (📖 90).</p>

Warning	Description
 CAN NOT CROP	 pictures can not be cropped.
CAN NOT CROP	The picture is damaged or was not created with the camera.
CANNOT RESIZE	 pictures can not be resized.
CAN NOT ROTATE	An attempt was made to rotate a picture that can not be rotated.
 CAN NOT ROTATE	Movies can not be rotated.
 CANNOT EXECUTE	Red-eye removal can not be applied to the selected picture.
 CANNOT EXECUTE	Red-eye removal can not be applied to movies.
NO CARD	No memory card inserted when  COPY is selected. Insert a memory card.
 NO IMAGE	The source selected for  COPY contains no images. Select a different source.
 NO IMAGE	

Warning	Description
COMMUNICATION ERROR	A connection error occurred while pictures were being printed or copied to a computer or other device. Confirm that the device is turned on and that the USB cable is connected.
PRINTER ERROR	Printer out of paper or ink, or other printer error. Check printer (see printer manual for details). To resume printing, turn the printer off and then turn it back on.
PRINTER ERROR RESUME?	Printer out of paper or ink, or other printer error. Check printer (see printer manual for details). If printing does not resume automatically, tap OK to resume.
CANNOT BE PRINTED	An attempt was made to print a movie, a picture not created with the camera, or a picture in a format not supported by the printer. Movies and some pictures created with other devices can not be printed; if the picture is a still picture created with the camera, check the printer manual to confirm that the printer supports the JFIF-JPEG or Exif-JPEG format. If it does not, the pictures can not be printed.

Appendix

Tips and Tricks

The following tips and tricks will help you get the most from your camera.

Battery Performance

Choose the following settings for improved battery performance:

-  **FACE DETECTION** (📖 85): **OFF**
-  **AF MODE** (📖 86):  **CENTER**
-  **POWER MANAGEMENT** (📖 99):  **POWER SAVE**

The Silent Mode

Turning on the silent mode (📖 94) disables the speaker and flash in situations in which camera sounds or lights may be unwelcome.



The Self-timer

- **To prevent blur** caused by the camera moving when the shutter button is pressed, use the two-second timer.
- **To turn the timer off**, tap **BACK** (🔙 and 🔚), press the shutter button halfway (📷 and 📷), or tap **STOP** (🛑).



 **Intelligent Face Detection**

When **ON** is selected for  **FACE DETECTION** (📖 45), you can:





Shooting

- **Zoom in on faces** when **ZOOM(CONTINUOUS)** is selected for  **IMAGE DISP.** (📖 96).

Playback

- **Remove red-eye** by selecting **ON** for  **RED EYE REMOVAL** (📖 99).
- **Zoom in on faces** during slide shows (📖 89) or by tapping  during playback zoom.
- **Search for faces** using  **IMAGE SEARCH** (📖 58).

 **Pro Tips**

- To photograph the same scene both with and without the flash, select  **NATURAL & FLASH** for shooting mode (📖 37). Use  **PICTURE COMPARE** (📖 88) to compare the two shots.
- To photograph subjects that are in motion,  **TOUCH & TRACK** for  **AF MODE** (📖 86).
- To photograph night scenes, select  **HIGH ISO & LOW NOISE** in **EXR** mode (📖 30) and turn the flash on (📖 41).

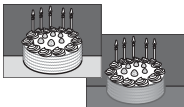

Internal Memory/Memory Card Capacity

The following table shows the recording time or number of pictures available at different image sizes. All figures are approximate; file size varies with the scene recorded, producing wide variations in the number of files that can be stored. The number of exposures or length remaining may not diminish at an even rate. A limited number of test pictures can be taken when no memory card is inserted.









Medium		Internal memory (approx. 62 MB)		4 GB		8 GB	
		FINE	NORMAL	FINE	NORMAL	FINE	NORMAL
Photographs	L 4:3	9	15	620	990	1250	1990
	L 16:9	13	20	830	1310	1670	2640
	M 4:3	15	30	990	1930	1990	3880
	M 16:9	20	40	1300	2530	2620	5080
	S 4:3	31	59	1930	3640	3880	7320
	S 16:9	57	84	3540	5160	7110	10370
Movie	HD 1920	34 sec. (8 sec.)		38 min. (15 min.)		76 min. (15 min.)	
	HD 1280	45 sec. (8 sec.)		49 min. (15 min.)		98 min. (15 min.)	
	640	108 sec. (97 sec.)		115 min. (30 min.)		232 min. (30 min.)	
	HS 640×480	80 sec. (30 sec.)		85 min. (30 sec.)		172 min. (30 sec.)	
	HS 320×240	162 sec. (30 sec.)		172 min. (30 sec.)		345 min. (30 sec.)	
	HS 320×112	81 sec. (10 sec.)		86 min. (30 sec.)		172 min. (30 sec.)	

- ❖ The maximum length that can be recorded in a single clip is given in parentheses.
- ❖ Use a CLASS 4 card or better when recording HD or high speed movies.

Temperature Warning

The camera will turn off automatically before its temperature or the temperature of the battery rise above safe limits. Pictures taken when a temperature warning is displayed may exhibit higher levels of “noise” (mottling). Turn the camera off and wait for it to cool before turning it on again.

Specifications

System	
Model	Digital Camera FinePix Z950EXR
Effective pixels	16 million
Image sensor	½-in., EXR CMOS with primary color filter
Storage media	• Internal memory (approx. 62 MB) • SD/SDHC/SDXC memory cards
File system	Compliant with Design Rule for Camera File System (DCF) and Exif 2.3
File format	• Still pictures: Exif 2.3 JPEG (compressed) • Movies: MOV (H.264)
Image size (pixels)	• L 4:3: 4,608 × 3,456 • L 16:9: 4,608 × 2,592 • M 4:3: 3,264 × 2,448 • M 16:9: 3,264 × 1,840 • S 4:3: 2,304 × 1,728 • S 16:9: 1,920 × 1,080 •  Motion Panorama  : 1,080 × 7,680 (tall)/7,680 × 720 (wide) •  Motion Panorama  : 1,080 × 3,840 (tall)/3,840 × 720 (wide) •  Motion Panorama  : 1,080 × 2,560 (tall)/2,560 × 720 (wide) •  Motion Panorama  : 1,080 × 7,680 (tall)/7,680 × 720 (wide)
Lens	Fujinon 5 × optical zoom lens, F3.9 (wide angle) – F4.9 (telephoto)
Focal length	f=5 mm–25 mm (35-mm format equivalent: 28 mm–140 mm)
Digital zoom	Up to about 2.6 × with intelligent digital zoom (up to 13 × when combined with optical zoom)
Aperture	F3.9/F6.2 (wide angle), F4.9/F8.0 (telephoto)
Focus range (distance from front of lens)	Approx. 60 cm (1.9 ft.)–infinity (wide angle); 1.0 m (3.2 ft.)–infinity (telephoto) • Macro: approx. 9 cm–80 cm/3.5 in.–2.6 ft. (wide angle); 20 cm–80 cm/7.8 in.–2.6 ft. (telephoto)

System

Sensitivity	Standard output sensitivity equivalent to ISO 100, 200, 400, 800, 1600, 3200, 6400 (image size M or S); AUTO, AUTO (400), AUTO (800), AUTO (1600), AUTO (3200)
Metering	256-segment through-the-lens (TTL) matrix metering; MULTI
Exposure control	Programmed auto exposure, manual exposure
Exposure compensation	-2 EV – +2 EV in increments of 1/3 EV
Picture stabilization	Optical stabilization (image-sensor shift)
Shutter speed (combined mechanical and electronic shutter)	4 s–1/2,000 s <ul style="list-style-type: none"> • : 4 s–1/2 s • : 1/4 s–1/1,000 s • : 3 s–1/1,000 s <ul style="list-style-type: none"> • Other modes: 1/4 s–1/2,000 s
Continuous	<ul style="list-style-type: none"> • : Up to 3 fps, max. 12 frames • : Up to 6 fps, max. 12 frames • : Up to 12 fps, max. 12 frames
Focus	<ul style="list-style-type: none"> • Mode: Center AF, Multi AF, Touch & Track • Autofocus system: Contrast-detect AF
White balance	Auto, direct sunlight, shade, daylight fluorescent, warm white fluorescent, cool white fluorescent, incandescent
Self-timer	OFF; timer with approx. 2 s or 10 s delay; auto release (and); auto release; couple timer; group timer

System

Flash Auto flash; effective range when sensitivity is set to **ISO AUTO** is approx. 30 cm–3.0 m/0.9 ft.–9.8 ft. (wide angle), 1.0 m–2.1 m/3.2 ft.–6.8 ft. (telephoto)

Flash mode Auto, fill flash, off, slow sync (red-eye removal off); auto with red-eye reduction, fill flash with red-eye reduction, off, slow sync with red-eye reduction (red-eye removal on)

LCD monitor 3.5-in., 460k-dot color LCD monitor; frame coverage approx. 100%; aspect ratio 16 : 9

Movies

- **FHD 1920**: 1,920 × 1,080 (1080p), 30 fps
- **HD 1280**: 1,280 × 720 (720p), 30 fps
- **640**: 640 × 480 (VGA), 30 fps
- **HS 640 × 480**: 80 fps
- **HS 320 × 240**: 160 fps
- **HS 320 × 112**: 320 fps

Note: **FHD**, **HD**, and **640** movies are recorded with stereo sound.

Languages Arabic, Bulgarian, Simplified Chinese, Traditional Chinese, Czech, Danish, Dutch, English, Farsi, Finnish, French, German, Greek, Hebrew, Hungarian, Indonesian, Italian, Japanese, Kazakh, Korean, Latvian, Lithuanian, Norwegian, Polish, Portuguese, Romanian, Russian, Serbian, Slovak, Spanish, Swedish, Thai, Turkish, Ukrainian, Vietnamese

Input/output terminals**Digital input/output** USB 2.0 High-Speed; MTP/PTP**HDMI output** HDMI mini connector**Power supply/other**

- Power supply**
- NP-45A rechargeable battery
 - AC-5VX AC power adapter and CP-45 DC coupler (sold separately)

Battery life (approximate number of frames that can be taken with a fully-charged battery)

Battery type	Approximate number of frames
NP-45A (type supplied with camera)	220

CIPA standard, measured in  (auto) mode using battery supplied with camera and SD memory card.

Note: Number of shots that can be taken with battery varies with battery charge level and will decline at low temperatures.

Dimensions (W × H × D) 100.8 mm × 59.0 mm × 18.2 mm/3.9 in. × 2.3 in. × 0.7 in., excluding projections (minimum depth 15.2 mm/0.5 in.)

Shooting weight Approx. 151 g/5.3 oz., including battery and memory card

Camera weight Approx. 135 g/4.7 oz., excluding battery, accessories, and memory card

- Operating conditions**
- **Temperature:** 0 °C – +40 °C/+32 °F – +104 °F
 - **Humidity:** 10% – 80% (no condensation)

NP-45A rechargeable battery

Nominal voltage	DC 3.7 V
Nominal capacity	720 mAh
Operating temperature	0 °C – +40 °C/+32 °F – +104 °F
Dimensions (W × H × D)	31.0 mm × 39.6 mm × 6.0 mm/1.2 in. × 1.5 in. × 0.2 in.
Weight	Approx. 15.5 g/0.5 oz.

BC-45C battery charger

Rated input	100 V–240 V AC, 50/60 Hz	
Input capacity	• 100 V: 8.0 VA	• 240 V: 12 VA
Rated output	4.2 V DC, 550 mA	
Supported batteries	NP-45A rechargeable batteries	
Charging time	Approx. 110 minutes (+20 °C/+68 °F)	
Operating temperature	0 °C – +40 °C/+32 °F – +104 °F	
Dimensions (W × H × D)	46.2 mm × 90.0 mm × 27.6 mm/1.8 in. × 3.5 in. × 1.0 in., excluding projections	
Weight	Approx. 63 g/2.2 oz., excluding battery	

Weight and dimensions vary with the country or region of sale.

■ Notices

- Specifications subject to change without notice; for the latest information, visit http://www.fujifilm.com/products/digital_cameras/index.html. FUJIFILM shall not be held liable for damages resulting from errors in this manual.
- Although the LCD monitor is manufactured using advanced high-precision technology, small bright points and anomalous colors may appear, particularly in the vicinity of text. This is normal for this type of LCD monitor and does not indicate a malfunction; images recorded with the camera are unaffected.
- Digital cameras may malfunction when exposed to strong radio interference (e.g., electric fields, static electricity, or line noise).
- Due to the type of lens used, some distortion may occur at the periphery of images. This is normal.

FUJIFILM

FUJIFILM Corporation

7-3, AKASAKA 9-CHOME, MINATO-KU, TOKYO 107-0052, JAPAN

http://www.fujifilm.com/products/digital_cameras/index.html